

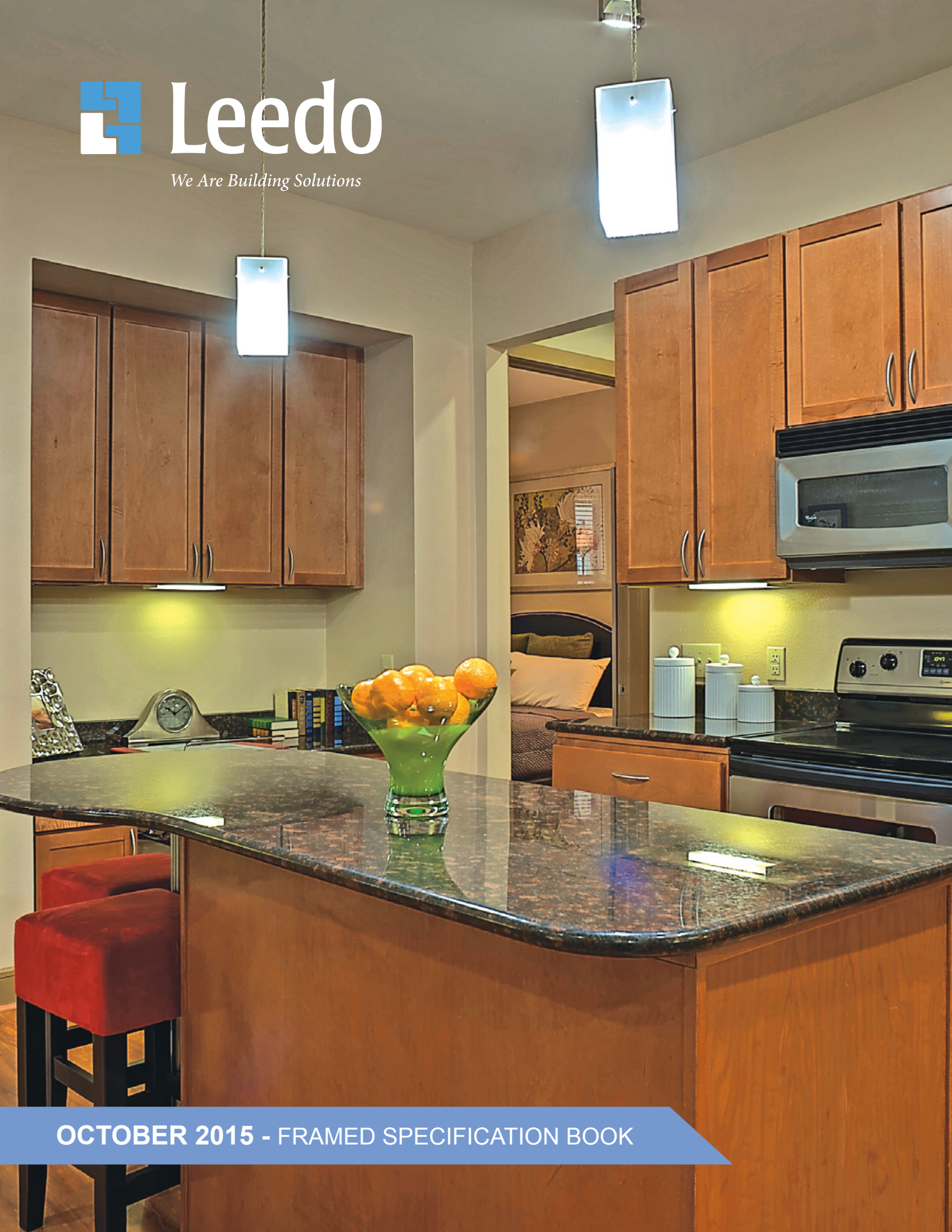

We Are Building Solutions



OCTOBER 2015 - FRAMED SPECIFICATION BOOK

2015 TRADITIONAL CATALOG

TABLE OF CONTENTS

Cabinet Specifications	4
Cabinet Construction	6
Modification Legend	7
Warranty	8
Door Style Options	9
Cabinet Care Guide	15
Base Cabinets	17
Accessible Base	22
Vanity Base	27
Desk Base	30
Wall Cabinets	32
Tall Cabinets	35
Accessories	39

TRADITIONAL PRODUCT SPECIFICATIONS

STANDARD CABINET CONSTRUCTION:

- Face frames are solid oak or maple, glued and nailed with mortise and tenon joints. Frame stiles and rails are 1½” wide and ¾” thick.
- Sides, tops, bottoms, shelves, hang rails, toe-kicks, fillers, skirts and drawer sides are constructed of ½” thick, medium density, industrial particleboard. Exposed surfaces are faced with melamine-coated laminate. Cabinet sides match the color of the cabinet face. Cabinet tops and bottoms match the interior color.
- Particleboard conforms to all the following Formaldehyde Emission Requirements:
 - a. ANSI 208.1 Table A
 - b. HUD CFR Part 3280
 - c. California Air Resources Board (CARB) phase II
- Particleboard is certified by the Composite Panel Association as complying to their Environmentally Preferable Product (EPP) specification CPA 3-08:
 - a. California ARB approved third party certifier TPC-1
 - b. Contains 100% recycled and/or recovered fibers (pre-consumer)
 - c. Complies with CPA EPPS 3-08, ANSI A208.1, HUD 24 CFR Part 3280, and CCR 93120 (CARB Composite Wood ATCM Phase 1)
- Decorative toe-kick overlay is 1/8” thick, melamine-faced hardboard
- Back panels are 1/8” MDF faced with melamine-coated laminate complies with CARB PH II and certified by PSI-TPC#01

DRAWERS:

- Drawers feature a five-sided box. ½” thick sides are rabbet-jointed, glued, and nailed to front and back.
- Drawer box bottoms are ¼” particleboard core, faced with melamine-coated laminate, except drawer boxes 15” wide or narrower, which have bottoms of 1/8” MDF faced with melamine-coated laminate.
- The powder-coated steel drawer runners screwed to each side, anchor the drawer bottoms in place. Drawers are installed with self-adjusting mounting brackets.
- Standard drawer slides are nylon-tired, self-closing, 55-pound rated, side-mounted, powder-coated steel.

DOORS:

- Raised panel doors feature solid oak or maple stiles and rails. Raised panel is plywood consisting of two oak or maple veneer faces and an inner particleboard core.
- Flat panel doors feature solid oak or maple stiles and rails. Center panel is plywood consisting of two oak or maple veneer faces and an inner particleboard core.
- Thermofused melamine doors are 5/8” thick with a true fused, melamine impregnated back.
- Thermofoil (3D Laminate) doors are 5/8” thick with a fused, melamine impregnated back and a durable vinyl film formed to the front and edges

TRADITIONAL PRODUCT SPECIFICATIONS

PLYWOOD UPGRADE CABINET CONSTRUCTION:

- Face frames are solid oak or maple, glued and nailed with mortise and tenon joints. Frame stiles and rails are 1-1/2" wide and 3/4" thick.
- Sides, tops, bottoms, shelves, hang rails, toe-kicks, fillers, skirts and drawer sides are constructed of 1/2" thick plywood. Exposed surfaces are faced with melamine-coated laminate. Cabinet sides match the color of the cabinet face. Cabinet tops and bottom match the interior color.
- Decorative toe-kick overlay is 3.6mm thick, melamine-faced plywood. Back panels are 3.6mm thick plywood, faced with melamine-coated laminate.

DRAWERS:

- Drawers feature a five-sided box. Sides are 1/2" thick plywood, faced with melamine coated laminate, rabbet-jointed, glued, and nailed to front and back.
- Drawer bottoms are 5.2mm plywood, faced with melamine-coated laminate. Bottoms are inset into dado groove in the drawer sides. The powder-coated steel drawer runner is screwed to each side anchor.
- Drawers are installed with self-adjusting mounting brackets.
- Standard drawer slides are nylon-tired, self-closing, 55-pound rated, side-mounted powder-coated steel.

DOORS:

- Raised panel doors feature solid oak or maple stiles and rails. Raised panel is plywood consisting of two oak or maple veneer faces and an inner particleboard core.
- Flat panel doors feature solid oak or maple stiles and rails. Center panel is plywood consisting of two oak or maple veneer faces and an inner particleboard core.
- Thermofused melamine doors are 5/8" thick with a true fused, melamine impregnated back.
- Thermofoil (3D Laminate) doors are 5/8" thick MDF with a fused, melamine impregnated back and a durable vinyl film formed to the front and edges.

CABINET CONSTRUCTION

BASE CABINET

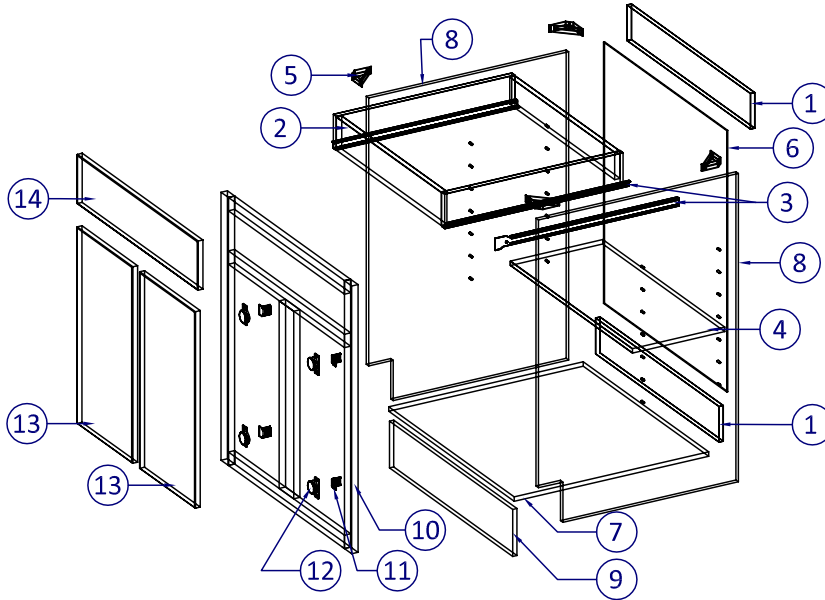

1. 1/2" stretcher
2. 1/2" drawer box with 1/8" bottom particleboard shown
3. Epoxy coated drawer slide
4. 1/2" half-depth adjustable shelf
5. Corner block
6. 1/8" back panel
7. 1/2" bottom
8. 1/2" end panel
9. 1/2" toekick
10. Faceframe
11. Hinge mounting plate
12. Hinge
13. Door
14. Drawer front

WALL CABINET

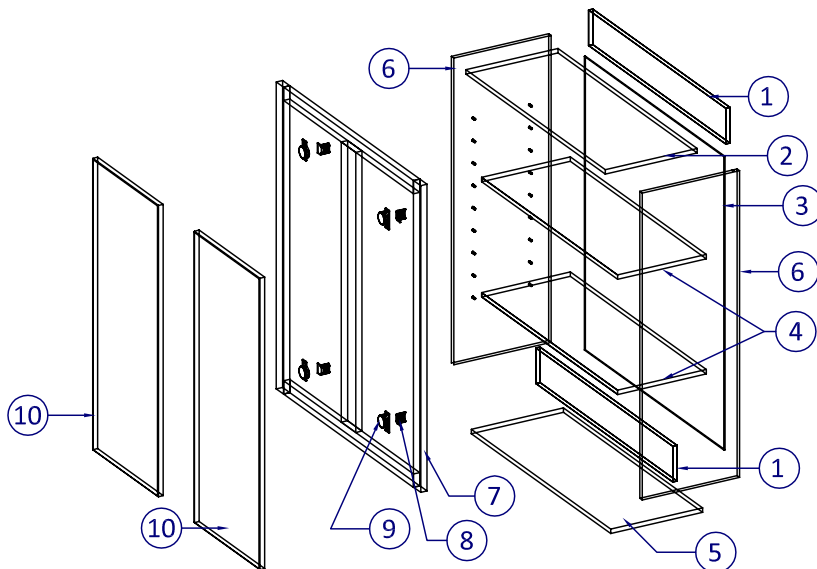

1. 1/2" stretcher
2. 1/2" top
3. 1/8" back panel
4. 1/2" adjustable shelf
5. 1/2" bottom
6. 1/2" end panel
7. Faceframe
8. Hinge mounting plate
9. Hinge
10. Door

MODIFICATION LEGEND

NCM - No Center Mullion (Option Max is 36")

NTK - No Toe Kick

DRAWER BOX OPTIONS



PARTICLEBOARD - STANDARD

- 1/2" particleboard, 5 sided box
- Applied bottom is secured by staples and reinforced by epoxy-coated slides
- Hardboard bottom is either 1/8" for small drawers or 1/4" for drawers that are 15" or wider



PARTICLEBOARD FULL EXTENSION

- 1/2" particleboard, 5 sided box
- Captured bottom fits into a groove cut into the drawer sides, front and back
- Hardboard bottom is either 1/8" for small drawers or 1/4" for drawers that are 15" or wider



PLYWOOD

- 1/2" plywood sides and 3/16" plywood bottoms
- Captured bottom fits into a groove cut into the drawer sides, front and back
- Choice of standard or full extension slides



PLYWOOD DOVETAIL

- 1/2" plywood sides and 3/16" plywood bottoms
- Captured bottom fits into a groove cut into the drawer sides, front and back
- Dovetailed corners
- Choice of standard or full extension slides

WARRANTY INFORMATION



Thank you for selecting Leedo Cabinetry. Leedo works hard to provide an excellent product at a very competitive price. We guarantee all Leedo products for a period of ONE (1) year from the date of the completion of project installation to be free of defects in materials and manufacturing. During this period we agree to replace, at no cost to the owner, any portion of our work that is found defective.

While Leedo guarantees all structural aspects of our products for a period of one year, the following exclusions do apply:

- Due to the naturally occurring variations in wood, we do not guarantee uniformity of color, tone or grain pattern; nor do we guarantee that stain or finish colors will be free of minor inconsistencies caused by natural variations in pigments and materials.
- Damage caused by normal wear and tear, abuse, neglect, misuse, alterations, water damage, or other environmental conditions such as exposure to extreme temperatures or humidity.
- Work done by others, including refinishing or removal of cabinets.
- Touch-ups, door and drawer adjustments, or cosmetic work.
- Color changes that may occur due to natural aging of the wood or due to exposure to either natural or artificial light.
- Discoloration or dullness in the finish or wood stain that may occur after exposure to ultraviolet light.

Leedo Manufacturing will make the final determination on any warranty-related items. Should a defect in materials or workmanship occur, excluding those noted above, Leedo maintains the right to repair or replace the product at our discretion.

MAPLE

ASHTON



BUCKINGHAM



CHURCHILL



CONCORD SHAKER



FILLMORE



FREEPORT



HARTFORD SHAKER



MIDLAND SHAKER



PLANO



RADISSON



ROOSEVELT

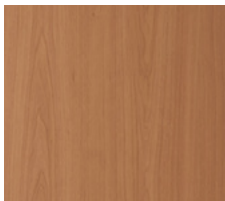

Light Cherry



Toffee

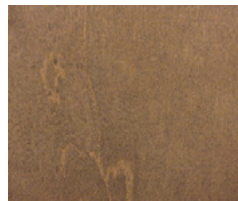

Chestnut

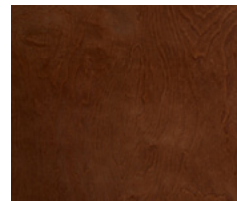

Pecan



Walnut



Java

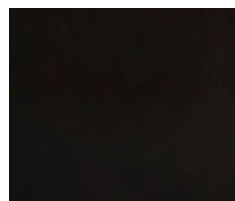

Espresso

OAK

BROOKSHIRE



FLEMING



HUNTINGTON



Western Wheat



Toffee

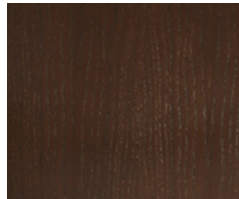

Walnut



Nutmeg

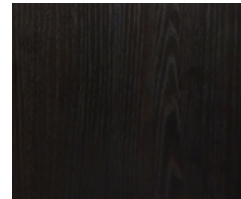

Espresso

THERMOFOIL

ANDOVER



BLANCO



BRIDGEPORT



CENTENNIAL



MIDTOWN



SAVANNAH



VANCOUVER



WASHINGTON

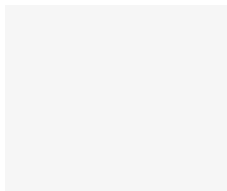

Centex White (smooth)

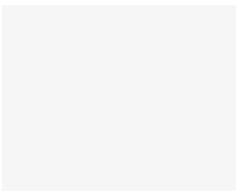

White



Snow White Gloss



Wood Grain White



Western Wheat

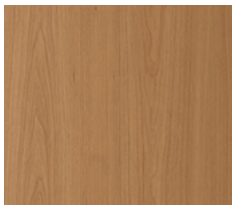

Light Cherry

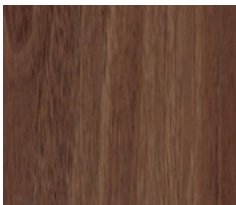

Cocoa Pecan

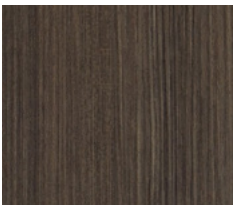

Olivewood



Euro Wenge



Java

TRU TOUCH

LONDON

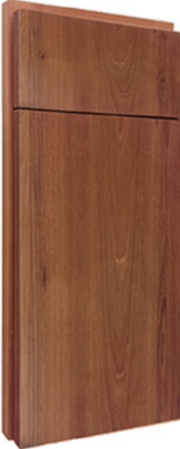

Toffee

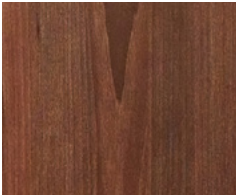

Pecan

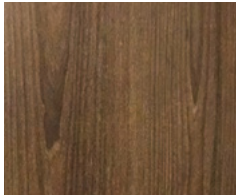

Chestnut

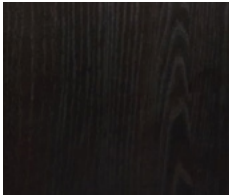

Espresso

TEXTURED LAMINATE

LUCINA



Texas Cypress

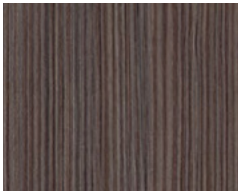

Light Teak



Midnight Teak

SMOOTH LAMINATE

ASTORIA

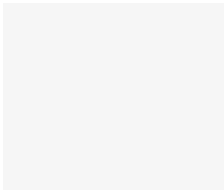

White

CABINET CARE GUIDE

A soft cotton cloth dampened with warm water is usually sufficient to clean your cabinets. If more thorough cleaning is required, use on the following cleaning solutions:

- A mixture of dishwashing liquid and warm water.
- A mild all-purpose cleaner. Make sure it does not contain ammonia, silicone, or acid.

Using the mildest cleaning solution will successfully clean your cabinets. Stronger products may damage or discolor your cabinet finish and are not recommended. After cleaning, wipe all surfaces with a clean, damp cloth. Dry immediately, using another soft, clean cloth.

Spills

Clean spills immediately. Prolonged exposure to spills, including food, water or other liquids, or grease spills can cause permanent discoloration or damage to your cabinet's finish.

Cleaning Product to Avoid

- Harsh chemicals including ammonia and bleach.
- Abrasive cleaning products such as tub and sink cleaners scouring powder, scouring pads, or steel wool.
- Sponges or dish clothes. They may contain particles that could scratch your cabinets, or they may contain food and oil residue.
- Solvent-based or petroleum-based products such as mineral spirits, nail-polish removers or paint thinners.
- Silicone-based cleaning, waxing or polishing products.

Regular Dusting

Use a clean, soft, lint-free cotton cloth for regular dusting. Packaged dusting sheets are not required or recommended. Do not use pre-moistened dusting sheets or aerosol products specified for dusting.

Waxing and Polishing

Waxing is not required or recommended. Over time, waxing and polishing compounds may build up on the surface of your cabinets and cause a hazy, streaky or yellowed appearance.



Gables Upper Kirby



Camden Gaines Ranch



Avalon Bloomingdale

CODE TEMPLATE:

CODE: B

WIDTH: 15

DEPTH: 21

B15-L-21D*

*Non std depth
added to code

CABINET DEPTH:

24 (STD), 21

DRAWER DEPTH:

19

HEIGHT: | NTK HEIGHT:

34-1/2

30

DOORS:

- 09-24W Single Door
- Specify Hinge L/R on 09-24 Wide
- 24-39W Double Door
- 3-inch increments

TOE KICK HEIGHT: 4-1/2

EXAMPLES:

B15-L, B24-L/R, B27, B15-L-21D, B27-21D

BASE CABINETS

B Base Single Door and Drawer

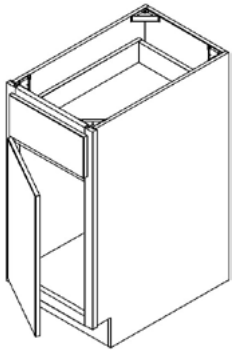

Width: 9, 12, 15, 18, 21, 24
Depth: 21, 24
Shelves: 1 Adj. half depth

NTK

B Base Single Drawer and Double Door

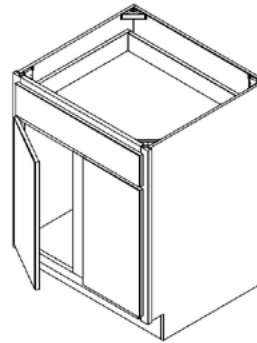

Width: 24, 27
Depth: 21, 24
Shelves: 1 Adj. half depth

NTK NCM

B Base Double Drawer and Door

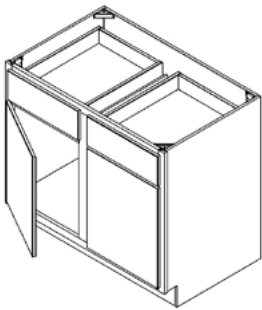

Width: 30, 33, 36, 39,
42, 45, 48
Depth: 21, 24
Shelves: 1 Adj. half depth

NTK NCM

BFHD Base Full Height Single Door

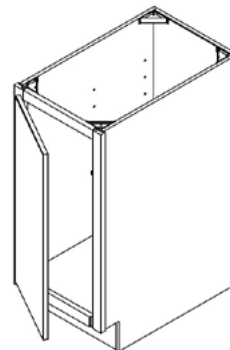

Width: 9, 12, 15, 18, 21, 24
Depth: 15, 18, 21, 24
Shelves: 1 Adj. half depth

BFHD Base Full Height Double Door

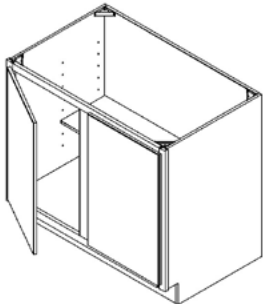

- Center mullion

Width: 24, 27, 30, 33, 36, 39,
42, 45, 48
Depth: 15, 18, 21, 24
Shelves: 1 Adj. half depth

NCM

D3B Base 3 Drawer

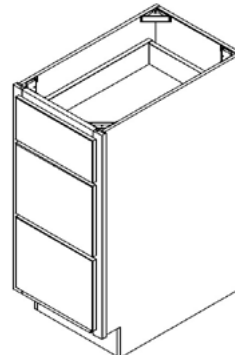

- Top drawer front is 5.5" tall
- Two equal size lower drawers

Width: 12, 15, 18, 21,
24, 27, 30, 36
Depth: 21, 24

D4B Base 4 Drawer

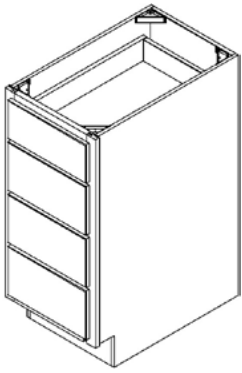

- Top drawer front is 5.5" tall
- Three equal size lower drawers

Width: 12, 15, 18, 21
24, 27, 30, 36

Depth: 21, 24

BBS Base Bookshelf

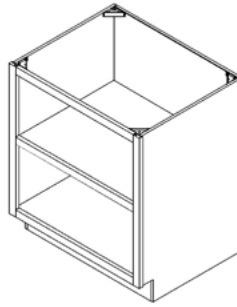

- Two equal openings
- Color matching interior
- Fixed middle rail

Width: 18, 21, 24, 27, 30
Depth: 12, 21, 24

B-TCP Single Trash Can Pullout

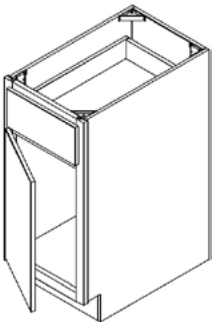

- One door
- One drawer
- One 35 qt. waste container

Width: 15, 18, 21
Depth: 24

B-DTCP Double Trash Can Pullout

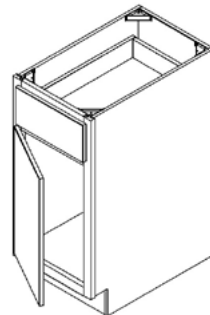

- One door
- One drawer
- Two 35 qt. waste containers

Width: 18, 21
Depth: 24

BFHD-TCP Single Trash Can Pullout

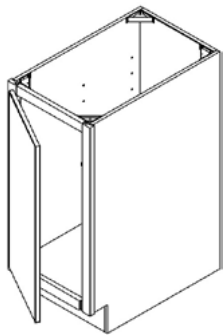

- One full height door
- One 35 qt. waste container

Width: 15, 18, 21
Depth: 24

BFHD-DTCP Double Trash Can Pullout

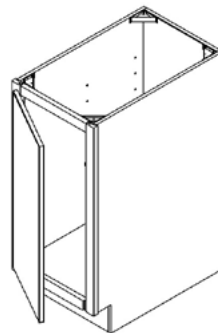

- One door
- Two 35 qt. waste containers

Width: 18, 21
Depth: 24

BWR Base Wine Rack

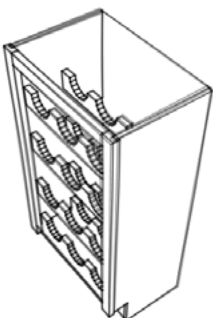

- Color matching interior

Width: 18, 21, 24,
27, 30

Depth: 12

BWRL Lattice Wine Rack

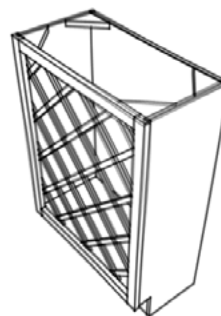

- Color matching interior

Width: 18, 21, 24,
Depth: 12

BBCL BCR Blind Base

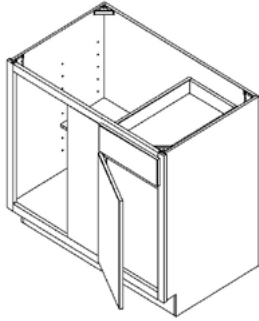

- One door
- One drawer

Width: 36, 39, 42, 45
Depth: 24

Installation example below

BBCLFHD BCRFHD Blind Base Full Height Door

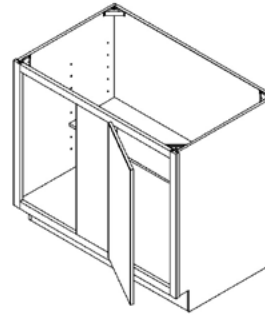

- One Door

Width: 15, 18, 21, 24
Depth: 24

Installation example below

Installation Example - Blind Corner Base

Item	Overall Cabinet Width	Replaces Cabinet and Filler for	Pull		Reach		Mullion Reveal	
			Min	Max	Min	Max	Min	Max
BBCL09 36-39	24	9	12	15	36	39	4.5	7.5
BBCL12 39-42	30	12	9	12	39	42	4.5	7.5
BBCL15 42-45	36	15	6	9	42	45	4.5	7.5
BBCL18 45-48	42	18	3	6	45	48	4.5	7.5

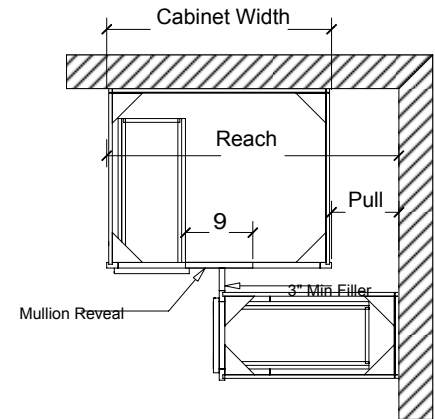

Designed to be pulled out of corner, see installation example at right. Specify L/R blind (blind right show). Blind Corner Base Cabinets can be reversed by relocating door and drawer. Filler is required. Order separately.

ERB Easy Reach Base

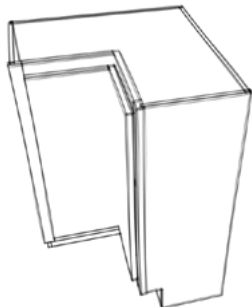

- One bifold door

Width: 33, 36
Depth: 12, 21, 24

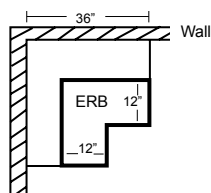

LSB Lazy Susan Base

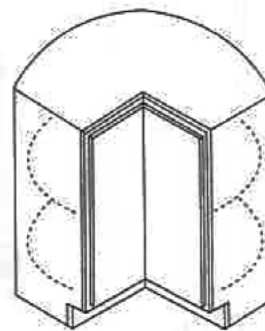

- One bifold door

Width: 36
Depth: 24

SB Sink Base

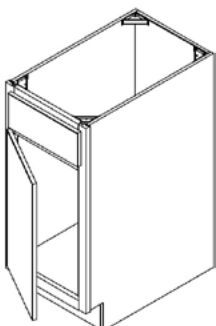

- One false front
- One door

Width: 18, 21, 24
Depth: 15, 18, 21, 24

SBFHD Sink Base Full Height Door

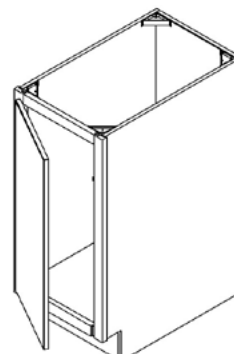

- One full height door

Width: 18, 21, 24
Depth: 15, 18, 21, 24

SB Sink Base

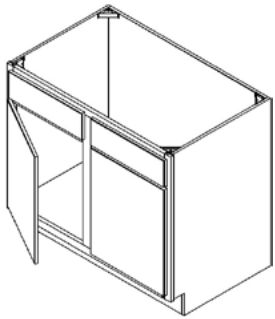

- Two false fronts
 - Two doors
- Width: 30, 33, 36, 39, 42, 45, 48
Depth: 15, 18, 21, 24

NCM

SB Sink Base

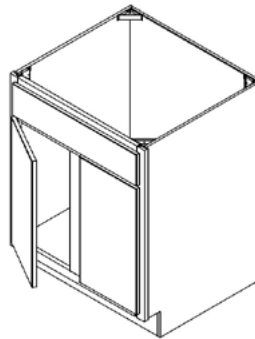

- One false front
 - Two doors
- Width: 24, 27
Depth: 15, 18, 21, 24

NCM

SBFHD Sink Base Full Height Door

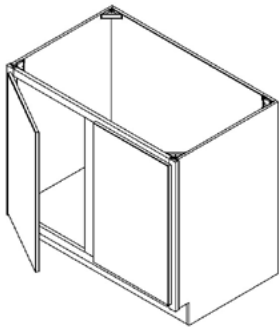

- Two full height doors
- Width: 24, 27, 30, 33, 36, 39, 42, 45, 48
Depth: 15, 18, 21, 24

NCM

CSB Combo Sink Base

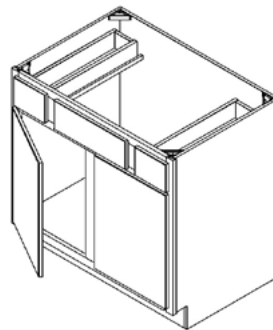

- One false front
 - Two doors
 - Two drawers
- Width: 36, 39, 42, 45, 48
Depth: 21, 24

DS Drawer Skirt

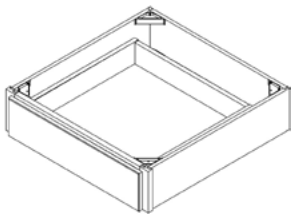

- Width: 18, 21, 24, 27, 30, 36
Depth: 21, 24
Height: 6

PD Pencil Drawer

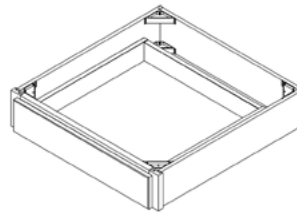

- Width: 18, 21, 24, 27, 30, 36
Depth: 21, 24
Height: 4

DST Drawer Skirt Trimmable

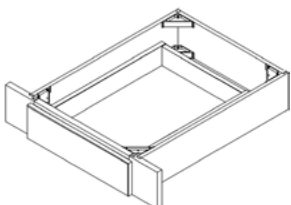

- Width: 18, 21, 24, 27, 30, 36
Depth: 21, 24
Height: 6

⚠ DST is trimmable and has 3" stiles.

PDT Pencil Drawer Trimmable

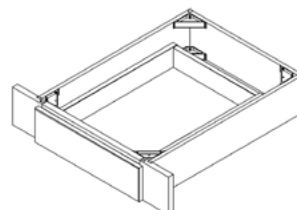

- Width: 18, 21, 24, 27, 30, 36
Depth: 21, 24
Height: 4

⚠ PDT is trimmable and has 3" stiles.

REMOVABLE CABINETS

REM-B Removable Base

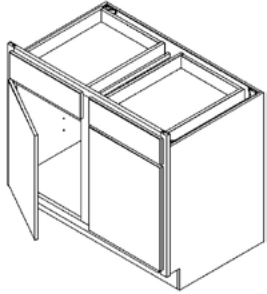

- Two drawers
 - Two doors
- Width: 30, 33, 36, 39,
42, 45, 48
Depth: 21, 24
Shelves: 1 Adj. half depth

NCM

⚠ End panels are 3" shorter than cabinet

REM-BFHD Removable Base FHD

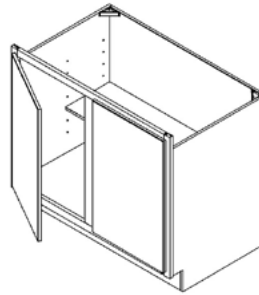

- Two doors
- Width: 30, 33, 36, 39,
42, 45, 49
Depth: 21, 24
Shelves: 1 Adj. half depth

⚠ End panels are 3" shorter than cabinet

UFAS-SB UFAS Sink Base

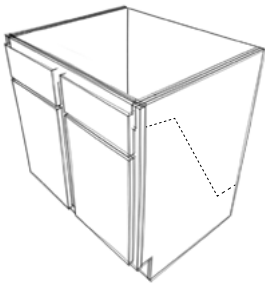

- Removable sink base
- Color matching interior

Width: 30, 33, 36
Depth: 21, 24

UFAS-SBFHD UFAS Sink Base FHD

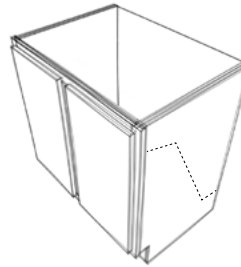

- Removable sink base
- Color matching interior

Width: 30, 33, 36
Depth: 21, 24

UFAS-SB-IO UFAS Sink Base Insert Only

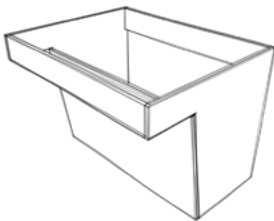

- Knee clearance height in SKU

Width: 30, 33, 36
Depth: 24, 21

REM-SB Removable SB

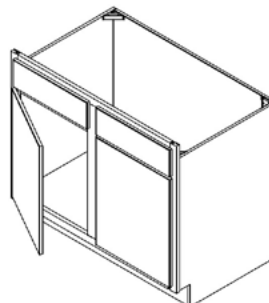

- Two false fronts
- Two doors

Width: 30, 33, 36, 39
Depth: 12, 15, 18, 21, 24

NCM

⚠ End panels are 3" shorter than cabinet

CABINET DEPTH:

24 (STD), 21

DRAWER DEPTH:

19

HEIGHT: NTK HEIGHT:

32-1/2

27

DOORS:

- 09-24W Single Door
- Specify Hinge L/R on 09-24 Wide
- 24-39W Double Door
- 3-inch increments

TOE KICK HEIGHT: 5-1/2**CODE TEMPLATE:****CODE:** HCB**WIDTH:** 15**DEPTH:** 21

HCB15-L-21D*

**Non std depth
added to code***EXAMPLES:**HCB15-L, HCB24-L/R, HCB27, HCB15-L-21D,
HCB27-21D

ACCESSIBLE CABINETS

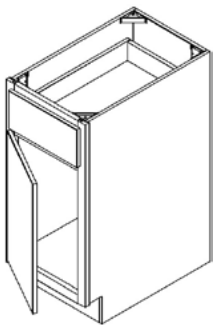
HCB HC Base

- One door
- One drawer

Width: 9, 12, 15, 18, 21, 24
Depth: 21, 24

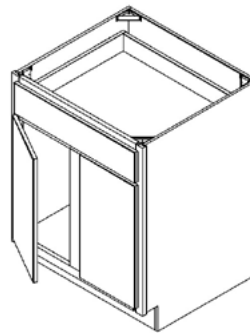
HCB HC Base

- Two doors
- One drawer
- Center mullion

Width: 24, 27
Depth: 21, 24

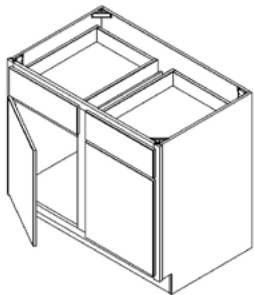
NCM**HCB HC Base**

- Two doors
- Two drawers
- Center Mullion

Width: 30, 33, 36, 39, 42, 45, 48
Depth: 21, 24

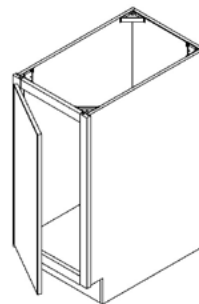
NCM**HCBFHD HC Base Full Height Door**

- One door

Width: 9, 12, 15, 18, 21, 24
Depth: 15, 18, 21, 24

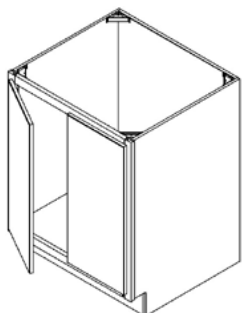
HCBFHD HC Base Full Height Door

- Two doors
- Center mullion

Width: 27, 30, 33, 36, 39,
42, 45, 48
Depth: 15, 18, 21, 24

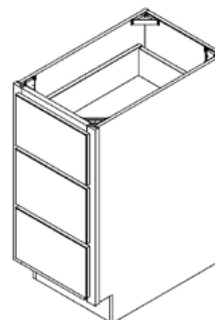
NCM**HCD3B HC Drawer 3 Base**

- Three equal sized drawers

Width: 12, 15, 18, 21, 24, 27,
30, 36
Depth: 21, 24

HCD4B HC Drawer 4 Base

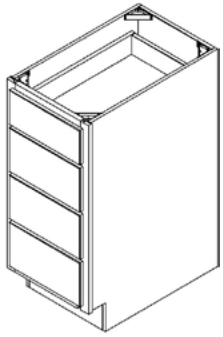

- Top drawer front 5.5" tall, remaining fronts equal
- Width: 12, 15, 18, 21, 24, 27, 30, 36
Depth: 21, 24

HCBS HC Base Bookshelf

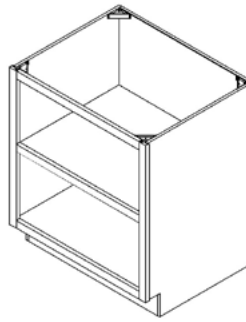

- Color matching interior
 - Fixed middle rail
- Width: 18, 21, 24, 27, 30
Depth: 12, 21, 24

HCB-TCP HC Single Trash Can Pullout

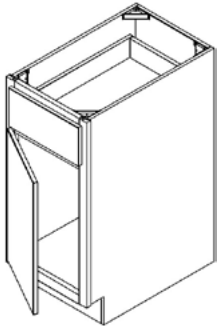

- One door
 - One drawer
 - One 35 qt. waste container
- Width: 15, 18, 21
Depth: 24

HCB-DTCP HC Double Trash Can Pullout

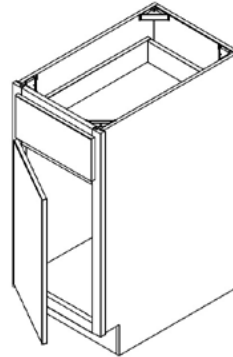

- One door
 - One drawer
 - Two 35 qt. waste containers
- Width: 18, 21
Depth: 24

HCBFHD-TCP HC FHD Trash Can Pullout

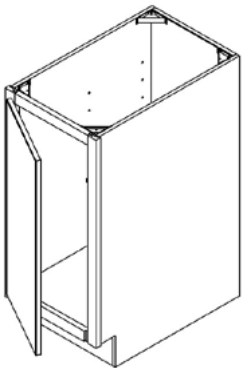

- One door
 - One 35 qt. waste container
- Width: 15, 18, 21
Depth: 24

HCBFHD-DTCP HC FHD Double Trash Can

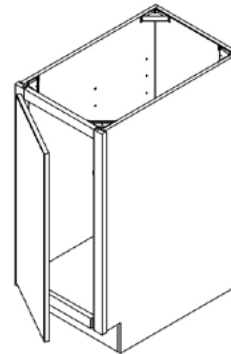

- One door
 - Two 35 qt. waste containers
- Width: 18, 21
Depth: 24

HCBBCL HCBBCR HC Blind Base

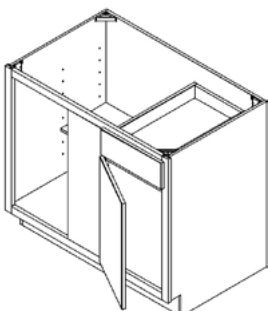

- One door
 - One drawer
- Width: 12, 15, 18, 21, 24
Depth: 24

HCBBCLFHD HCBBCRFHD HC Blind Base FHD

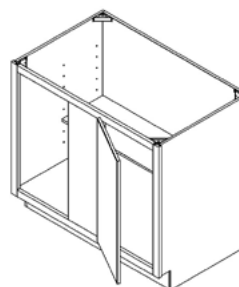

- One door
- Width: 12, 15, 18, 21, 24
Depth: 24

HCLSB HC Lazy Susan Base

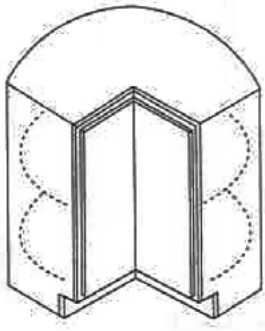

- Two doors

Width: 36
Depth: 24

HCERB HC Easy Reach Base

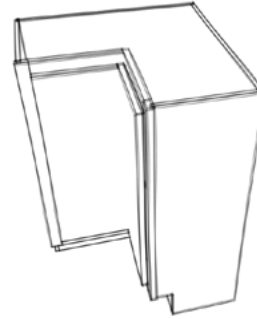

- Two doors

Width: 33,36
Depth: 21, 24

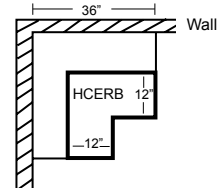

HCSBFHD HC Sink Base FHD

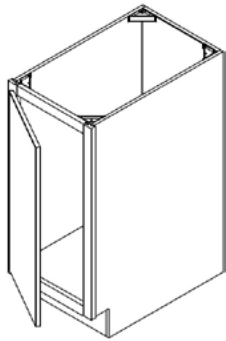

- One door

Width: 18, 21, 24
Depth: 15, 18, 21, 24

HCSBFHD HC Sink Base FHD

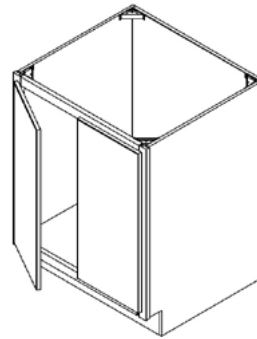

- Two doors
- Center mullion

Width: 24, 27, 30, 33, 36, 39,
42, 45, 48
Depth: 15, 18, 21, 24

NCM

HCSB HC Sink Base

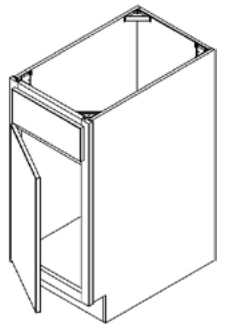

- One door
- One false front

Width: 15, 18, 21, 24
Depth: 12, 15, 18, 21, 24

HCSB HC Sink Base

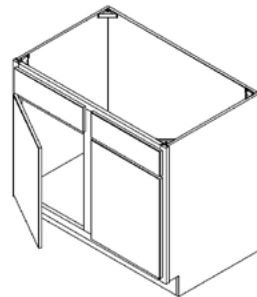

- Two doors
- Two false front

Width: 30, 33, 36, 39, 42,
45, 48
Depth: 15, 18, 21, 24

NCM

HCSB HC Sink Base

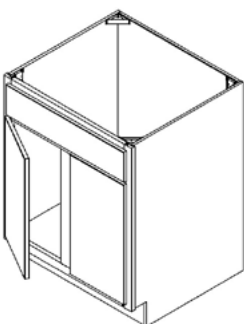

- Two doors
- One false front

Width: 24, 27
Depth: 15, 18, 21, 24

NCM

HCCSB Combo Sink Base

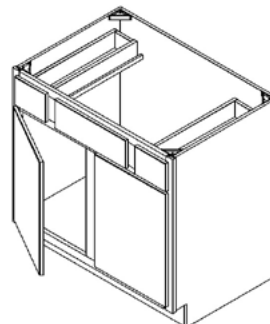

- Two drawers
- Two doors
- One false front

Width: 36, 39, 42,
45, 48
Depth: 21, 24

HCBWRL HC Lattice Wine Rack



- Color matching interior

Width: 18, 21, 24
Depth: 12

HCBWR HC Base Wine Rack

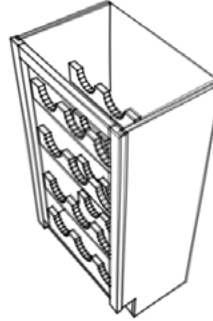

- Color matching interior

Width: 18, 21, 24, 27, 30
Depth: 12

REMOVABLE CABINETS

REM-HCB HC Removable Base

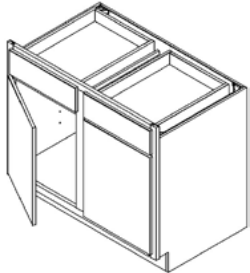

- Two doors
- Two drawers

Width: 30, 33, 36, 39, 42, 45, 48
 Depth: 21, 24

NCM

⚠ End panels are 3" shorter than cabinet

REM-HCBFHD Removable Base FHD

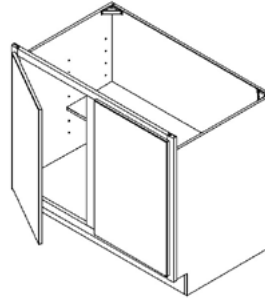

- Two doors

Width: 30, 33, 36, 39,
 42, 45, 48
 Depth: 21, 24

NCM

⚠ End panels are 3" shorter than cabinet

UFAS-HCSB UFAS HC Sink Base

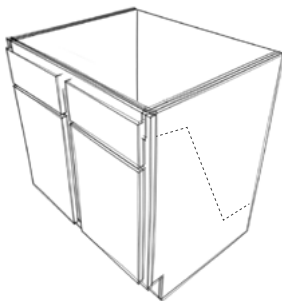

- Color matching interior

Width: 30, 33, 36
 Depth: 21, 24

NCM

UFAS-HCSBFHD UFAS HC Sink Base FHD

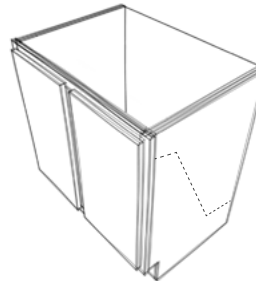

- Color matching interior

Width: 30, 33, 36
 Depth: 21, 24

NCM

UFAS-SB-IO UFAS Sink Base Insert Only

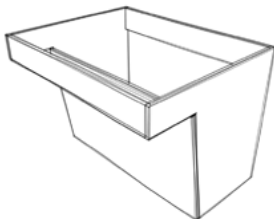

- Knee clearance height in SKU

Width: 30, 33, 36
 Depth: 24, 21

REM-HCSB Removable Sink Base

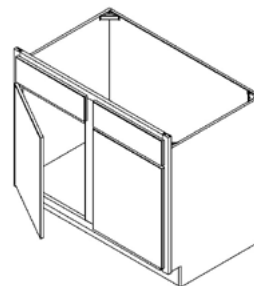

- Two doors
- Two false front

Width: 30, 33, 36, 39,
 Depth: 12, 15, 18, 21, 24

NCM

CABINET DEPTH:

24, 21 (STD)

DRAWER DEPTH:

19

HEIGHT:

31-1/2

DOORS:

- 09-24W Single Door
- Specify Hinge L/R on 09-24 Wide
- 24-39W Double Door
- 3-inch increments

TOE KICK HEIGHT: 4-1/2**CODE TEMPLATE:****CODE:** VB**WIDTH:** 15**DEPTH:** 24
 } VB15-L-24D*
 *Non std depth
 added to code
EXAMPLES:

VB15-L, VB24-L/R, VB27, VB15-L-24D, VB27-24D

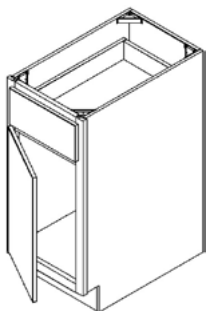
VANITY BASE CABINETS**VB** Vanity Base

- One door
- One drawer

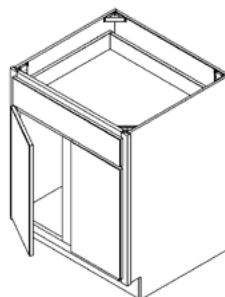
 Width: 9, 12, 15, 18, 21, 24
 Depth: 21, 24
VB Vanity Base

- Two doors
- One drawer

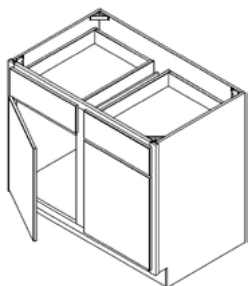
 Width: 24, 27
 Depth: 21, 24
NCM**VB** Vanity Base

- Two doors
- Two drawer

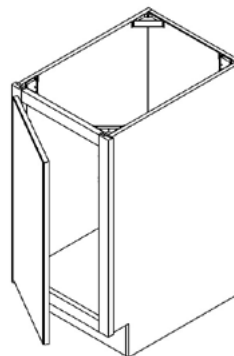
 Width: 30, 33, 36, 39, 42,
 45, 48
 Depth: 21, 24
NCM**VBFHD** VB Full Height Door

- One door

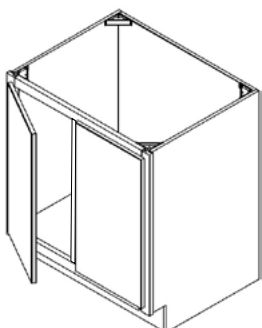
 Width: 9, 12, 15, 18, 21, 24
 Depth: 15, 18, 21, 24
VBFHD VB Full Height Door

- Two doors

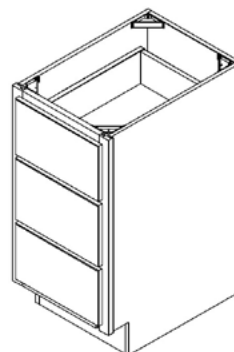
 Width: 24, 27, 30, 33, 36,
 39, 42, 45, 48
 Depth: 15, 18, 21, 24
NCM**VD3B** Base 3 Drawer

- Three drawer
- Equal sized drawers

 Width: 12, 15, 18, 21, 24,
 27, 30, 36
 Depth: 18, 21, 24

All drawer fronts are equal height

VD4B Base 4 Drawer

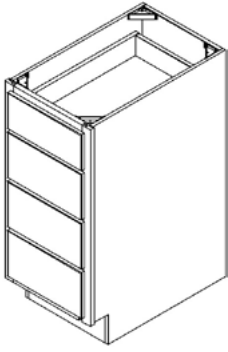

- Four drawer
- Top drawer front is 5.5" tall

Width: 12, 15, 18, 21, 24,
27, 30, 36

Depth: 18, 21, 24

⚠ Top drawer front 4.5" tall, remaining drawer fronts are equal

VSB Vanity Sink Base

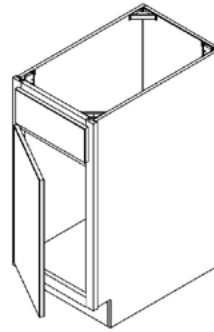

- One door
- One false front

Width: 18, 21, 24

Depth: 15, 18, 21, 24

VSB Vanity Sink Base

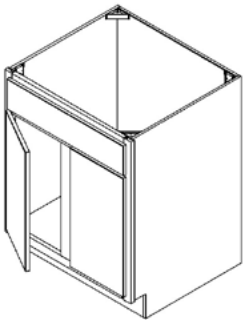

- Two doors
- One false front

Width: 24, 27

Depth: 15, 18, 21, 24

NCM

VSB Vanity Sink Base

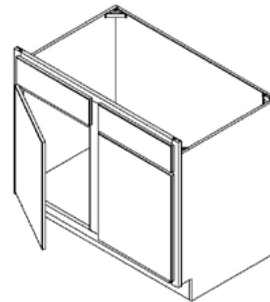

- Two doors
- Two false front

Width: 30, 33, 36, 39, 42,
45, 48

Depth: 15, 18, 21, 24

NCM

VSBFHD Vanity Sink Base FHD

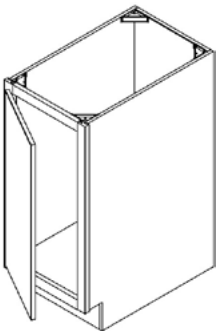

- One door

Width: 18, 21, 24

Depth: 15, 18, 21, 24

VSBFHD Vanity Sink Base FHD

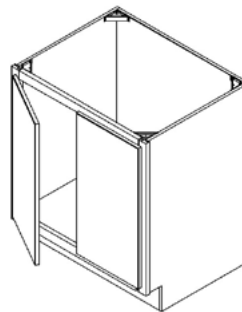

- Two doors
- Center mullion

Width: 24, 27, 30, 33, 36, 39,
42, 45, 48

Depth: 15, 18, 21, 24

NCM

CVSB Combo Vanity Sink Base

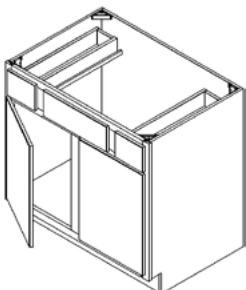

- Two doors
- One false front
- Two drawers

Width: 36, 39, 42, 45, 48

Depth: 21, 24

REMOVABLE CABINETS

REM-VB Removable Vanity Base

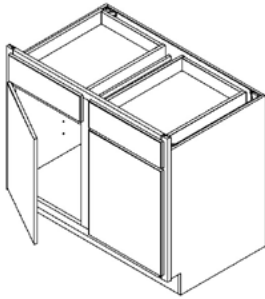

- Two doors
- Two drawers

Width: 30, 33, 36, 39, 42, 45, 48
 Depth: 21, 24

NCM

⚠ End panels are 3" shorter than cabinet

REM-VBFHD Removable Vanity Base FHD

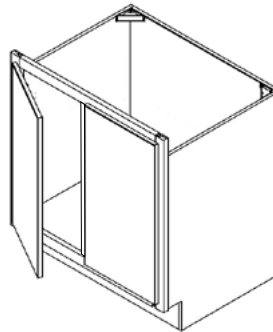

- Two doors

Width: 30, 33, 36, 39,
 42, 45, 48
 Depth: 21, 24

NCM

UFAS-VSB UFAS Vanity Sink Base

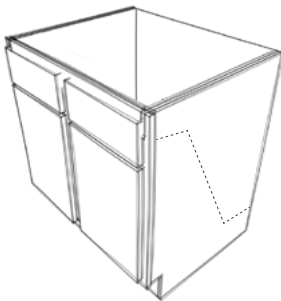

- Color matching interior

Width: 24, 27, 30, 33, 36, 39
 Depth: 21, 24

UFAS-VSBFHD UFAS Vanity Sink Base FHD

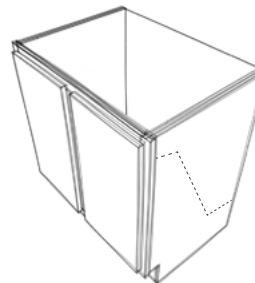

- Color matching interior

Width: 24, 27, 30, 33, 36, 39
 Depth: 21, 24

NCM

REM-VSB Removable Vanity Sink Base

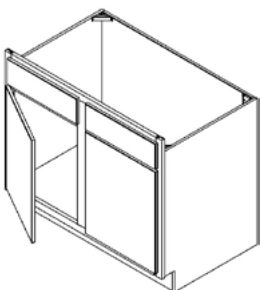

- Two doors
- Two false front

Width: 30, 33, 36, 39, 42,
 45, 48
 Depth: 12, 15, 18, 21, 24

NCM

CABINET DEPTH:
24 (STD), 21
DRAWER DEPTH:
19

HEIGHT: 28-1/2
NTK HEIGHT: 24

DOORS:

- 09-24W Single Door
- Specify Hinge L/R on 09-24 Wide
- 24-39W Double Door
- 3-inch increments

TOE KICK HEIGHT: 4-1/2

CODE OUTLINE:

CODE: DKB
WIDTH: 15
DEPTH: 21

} DKB15-L-21D*
**Non std depth added to code*

EXAMPLES:
DKB15-L, DKB24-L/R, DKB27, DKB15-L-21D, DKB27-21D

DESK BASE CABINETS

DKB Desk Base

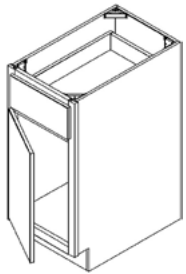

- One door
- One drawer

Width: 9, 12, 15, 18, 21, 24
Depth: 21, 24

NTK

DKB Desk Base

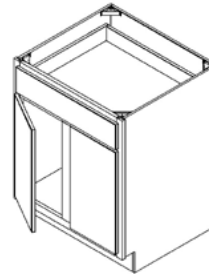

- Two doors
- One drawer
- Center mullion

Width: 24, 27
Depth: 21, 24

NTK NCM

DKB Desk Base

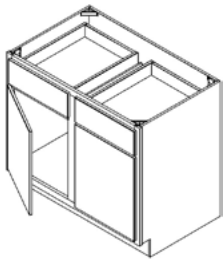

- Two doors
- Two drawers
- Center mullion

Width: 30, 33, 36, 39, 42, 45, 48
Depth: 21, 24

NTK NCM

DKBFHD Desk Base Full Height Door

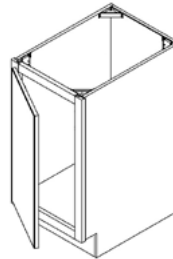

- One door

Width: 9, 12, 15, 18, 21, 24
Depth: 15, 18, 21, 24

DKBFHD DK Base Full Height Door

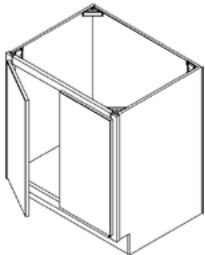

- Two doors
- Center mullion

Width: 24, 27, 30, 33, 36, 39, 42, 45, 48
Depth: 15, 18, 21, 24

NCM

DKBBS Desk Base Bookshelf

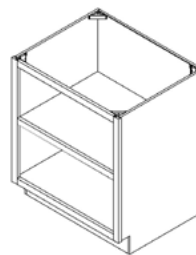

- Color matching interior
- Fixed middle rail

Width: 18, 21, 24, 27, 30
Depth: 12, 21, 24

DKD2B Base 2 Drawer

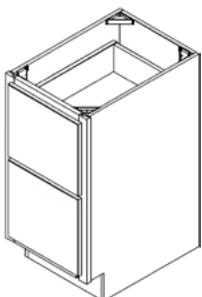

- Two drawer
- Equal sized drawers

Width: 18, 21
Depth: 18, 21, 24

⚠ All drawer fronts are equal height

DKD3B Base 3 Drawer

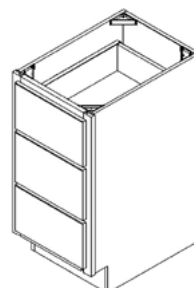

- Three drawer
- Top drawer front is 5.5" tall

Width: 12, 15, 18, 21, 24, 27, 30, 36
Depth: 18, 21, 24

CABINET DEPTH:

15, 12 (STD)

SHELF RULE:

12 – 18" No shelves

21 – 27" 1 Shelf

30 – 39" 2 Shelves

42" 3 Shelves

DOORS:

- 09-24W Single Door
- Specify Hinge L/R on 09-24 Wide
- 24-39W Double Door
- 3-inch increments

CODE TEMPLATE:**CODE: W****WIDTH: 15****DEPTH: 15**

W15-L-15D*
**Non std depth
 added to code*

EXAMPLES:

W09-L, W24-L/R, W27, W15-L-15D, W27-15D

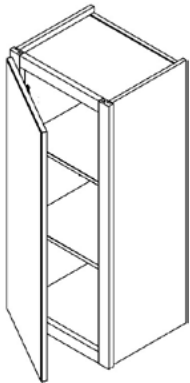
WALL CABINETS**W Wall**

- One door

Width: 9, 12, 15, 18, 21, 24
 Height: 12, 15, 18, 21, 24, 27,
 30, 36, 42
 Depth: 12, 15

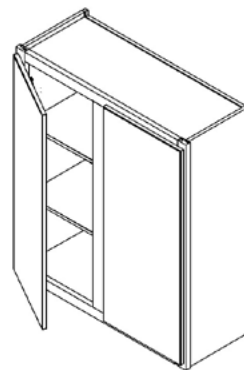
W Wall

- Two doors

Width: 24, 27, 30, 33, 36, 39
 Height: 12, 15, 18, 21, 24,
 27, 30, 36, 42
 Depth: 12, 15

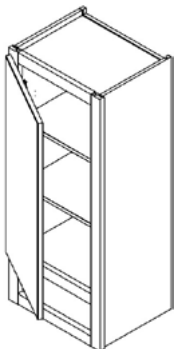
NCM**WL Wall Linen**

- One door
- Bottom fixed opening is 4.5"

Width: 21
 Height: 30
 Depth: 9, 12, 15

⚠ No shelves on 24" and 27" height

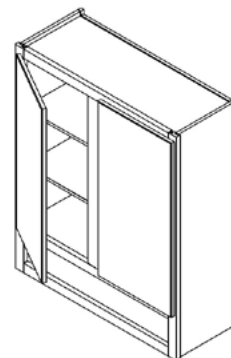
WL Wall Linen

- Two doors
- Bottom fixed opening is 4.5"

Width: 24, 27, 30
 Height: 30
 Depth: 9, 12, 15

NCM

⚠ No shelves on 24" and 27" height

MWC Microwave Wall

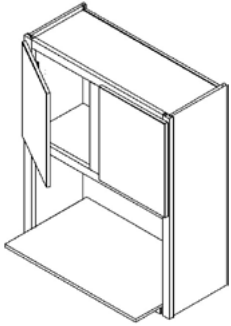

- Two doors
- Microwave opening is 13-1/2" high

Width: 24, 27, 30, 33, 36
Height: 30, 36, 42
Depth: 12, 24

NCM

⚠ Microwave shelf (MWS) has to be ordered separately

BS Wall Book Shelf

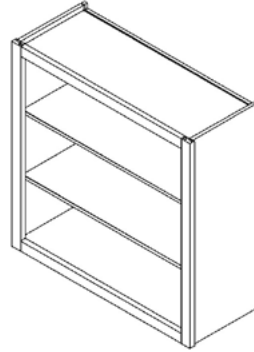

- Color matching interior

Width: 12, 15, 18, 21, 24, 27, 30
Height: 18, 21, 24, 27, 30, 36, 42
Depth: 9, 12, 15

WR Wine Rack

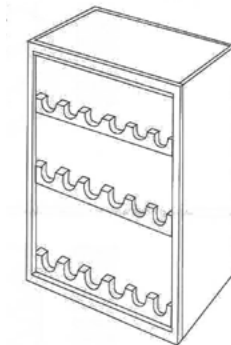

- Color matching interior

Width: 18, 21, 24, 27, 30
Height: 15, 18, 21, 24, 27, 30
Depth: 12

WRL Lattice Wine Rack

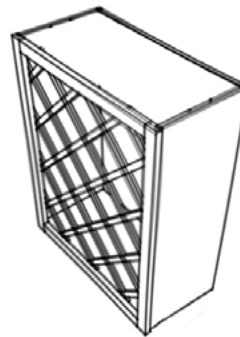

- Color matching interior
- 36" tall up to 18" wide
- 30" tall up to 24" wide
- 36" wide up to 18" tall
- 30 wide up to 24" tall

Width: 18, 21, 24, 27, 30
Height: 18, 21, 24, 27, 30, 36
Depth: 12

⚠ Size restrictions on certain dimensions - detailed above.

AW Angle Wall Cabinet

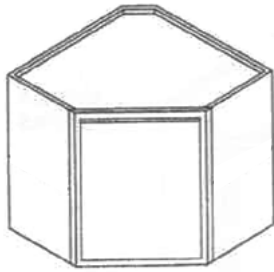

Width: 24
Height: 18, 24, 30, 36, 42
Depth: 12

AW Angle Wall Cabinet

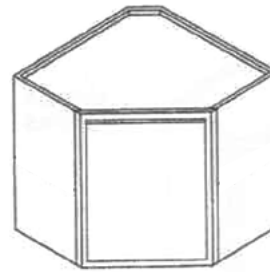

Width: 27
Height: 18, 24, 30, 36, 42
Depth: 15

WBCL
WBCR

Blind Wall Corner

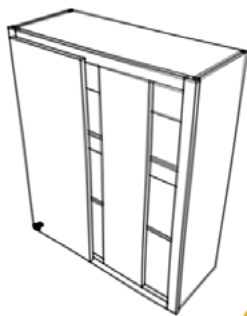

- One door

Width: 12, 15, 18, 21, 24
Height: 30, 36, 42
Depth: 12

Installation example below

WBCL
WBCR

Blind Wall Corner

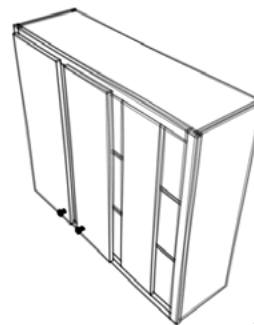

- Two door

Width: 24, 27, 30, 33, 36
Height: 30, 36, 42
Depth: 12

Installation example below

Full Overlay for Wall Blind Corner

Item	Cabinet Width	Cabinet Replaced	FO Pull		FO Reach	
			Min	Max	Min	Max
WBCL12xx	24	12	1.5	4.5	25.5	28.5
WBCL15xx	27	15	1.5	4.5	28.5	31.5
WBCL18xx	30	18	1.5	4.5	31.5	34.5
WBCL21xx	33	21	1.5	4.5	34.5	37.5

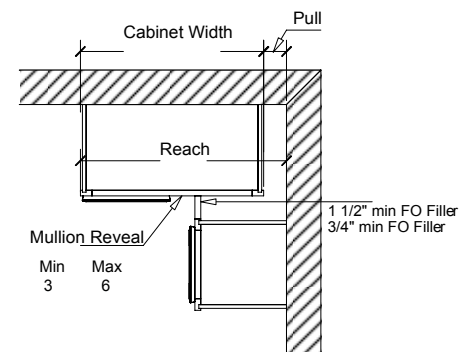

Standard Overlay for Wall Blind Corner

Item	Cabinet Width	Cabinet Replaced	SO Pull		SO Reach	
			Min	Max	Min	Max
WBCL12xx	24	12	.75	4.5	24.75	28.5
WBCL15xx	27	15	.75	4.5	27.75	31.5
WBCL18xx	30	18	.75	4.5	30.75	34.5
WBCL21xx	33	21	.75	4.5	33.75	37.5

ERW Easy Reach Wall

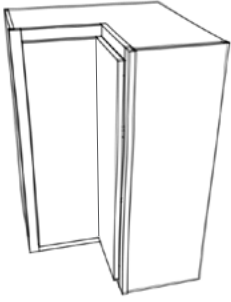

Width: 24, 27
Height: 30, 36, 42
Depth: 12, 15

MC Medicine Cabinet

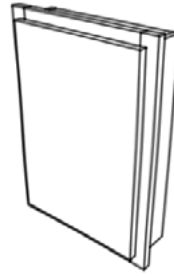

Width: 15
Height: 18, 21, 24, 27, 30, 36

CABINET DEPTHS:
12, 18, 21, 24

- DOORS:**
- 09-24W Single Door
 - Specify Hinge L/R on 09-24 Wide
 - 24-39W Double Door
 - 3-inch increments

CODE TEMPLATE:

CODE: P
WIDTH: 15
HEIGHT: 84
DEPTH: 21

} P1584-L-21D*
**Non std depth added to code*

EXAMPLES:
P1290-L, P2484-L/R, P2790, P1596-R-15D

TALL CABINETS

P Pantry Cabinet

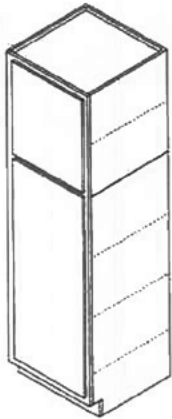

- One door top and bottom
- 4-1/2" toe kick

Width: 12, 15, 18, 24
 Height: 84, 90, 96
 Depth: 12, 18, 21, 24 (std)

NTK

P Pantry Cabinet

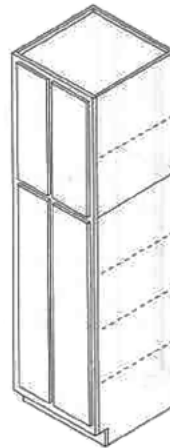

- Two doors top and bottom
- 4-1/2" toe kick

Width: 24, 27, 30, 33, 36
 Height: 84, 90, 96
 Depth: 12, 18, 21, 24 (std)

NTK

LC Linen Cabinet

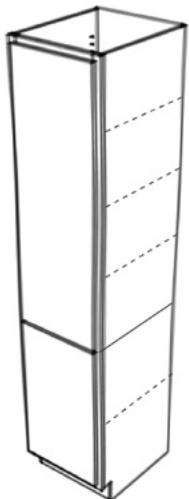

- One door top and bottom
- 4-1/2" toe kick

Width: 12, 15, 18, 24
 Height: 84, 90, 96
 Depth: 12, 18, 21, 24 (std)

NTK

LC Linen Cabinet

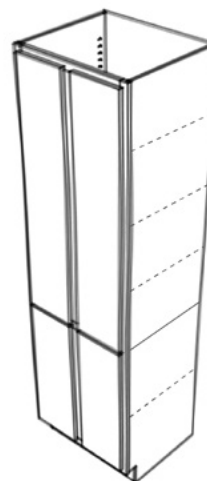

- Two doors top and bottom
- 4-1/2" toe kick

Width: 24, 27, 30, 33, 36
 Height: 84, 90, 96
 Depth: 12, 18, 21, 24 (std)

NTK

LHC Linen Hamper

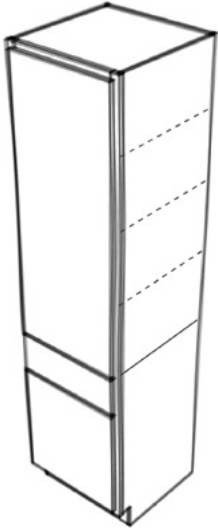

- One door top and bottom
- Flip down drawer front between doors
- 4-1/2" toe kick

Width: 12, 15, 18, 24
Height: 84, 90, 96
Depth: 12, 18, 21 (std), 24

NTK

LHC Linen Hamper

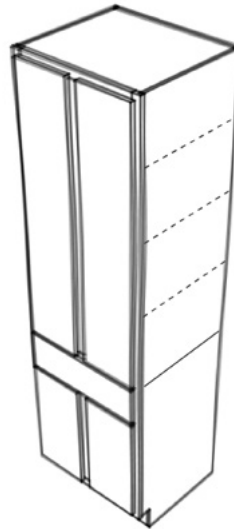

- Two doors top and bottom
- Flip down drawer front between doors
- 4-1/2" toe kick

Width: 24, 27, 30, 33, 36
Height: 84, 90, 96
Depth: 12, 18, 21 (std), 24

NTK

UC Single Utility Cabinet

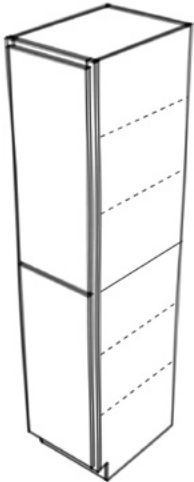

- One door top and bottom
- 4-1/2" toe kick

Width: 12, 15, 18, 24
Height: 84, 90, 96
Depth: 12, 18, 21, 24 (std)

NTK

UC Double Utility Cabinet

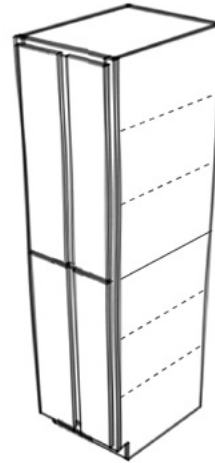

- Two doors top and bottom
- 4-1/2" toe kick

Width: 24, 27, 30, 33, 36
Height: 84, 90, 96
Depth: 12, 18, 21, 24 (std)

NTK

TBS Tall Bookshelf

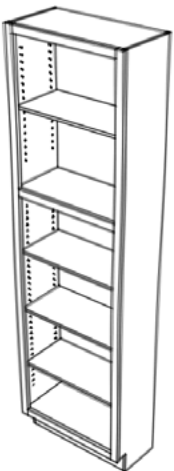

- Color matching interior

Width: 12, 15, 18, 24, 27,
30, 33, 36
Height: 84, 90, 96
Depth: 12, 18, 21, 24

TALL ACCESSIBLE CABINETS

HCP HC Pantry Cabinet

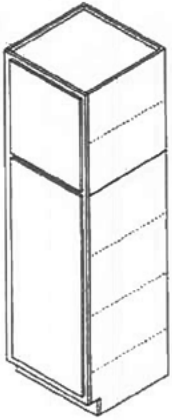

- One door top and bottom
- 5-1/2" toe kick

Width: 12, 15, 18, 24
 Height: 84, 90, 96
 Depth: 12, 18, 21, 24 (std)

NTK

HCP HC Pantry Cabinet

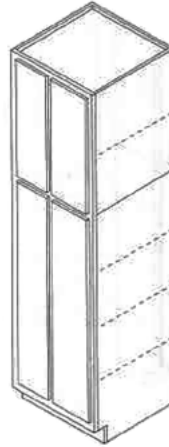

- Two doors top and bottom
- 5-1/2" toe kick

Width: 24, 27, 30, 36
 Height: 84, 90, 96
 Depth: 12, 18, 21, 24 (std)

NTK

HCLC HC Linen Cabinet

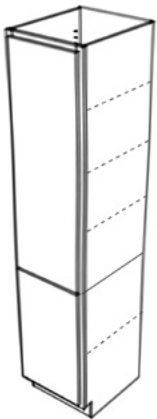

- One door top and bottom
- 5-1/2" toe kick

Width: 12, 15, 18, 24
 Height: 84, 90, 96
 Depth: 12, 18, 21, 24 (std)

NTK

HCLC HC Linen Cabinet

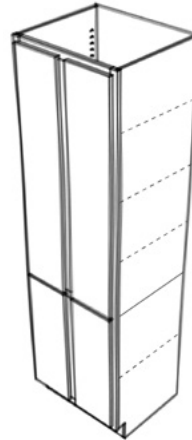

- Two doors top and bottom
- 5-1/2" toe kick

Width: 24, 27, 30, 33, 36
 Height: 84, 90, 96
 Depth: 12, 18, 21, 24 (std)

NTK

HCLHC HC Linen Hamper

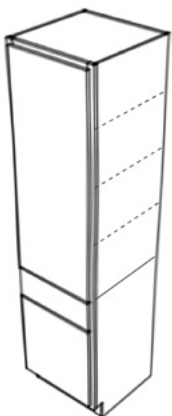

- One door top and bottom
- 5-1/2" toe kick

Width: 12, 15, 18, 24
 Height: 84, 90, 96
 Depth: 12, 18, 21 (std), 24

NTK

HCLHC HC Linen Hamper

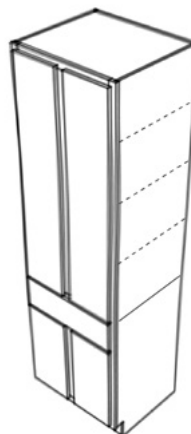

- Two doors top and bottom
- 5-1/2" toe kick

Width: 24, 27, 30, 33, 36
 Height: 84, 90, 96
 Depth: 12, 18, 21 (std), 24

NTK

TALL ACCESSIBLE CABINETS

HCUC HC Single Utility Cabinet

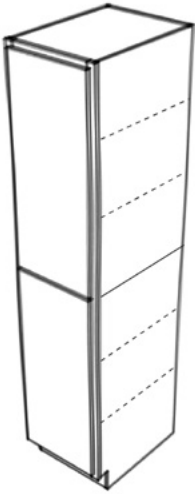

- One door top and bottom
- 5.5" toe kick

Width: 12, 15, 18, 24, 27,
30, 33, 36
Height: 84, 90, 96
Depth: 12, 18, 21, 24 (std)

NTK

HCUC HC Double Utility Cabinet

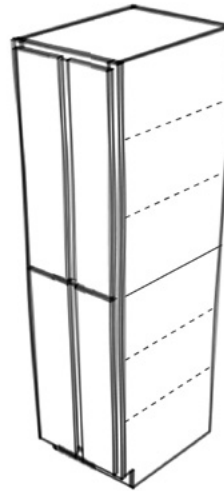

- Two doors top and bottom
- 5-1/2" toe kick

Width: 24, 27, 30, 33, 36
Height: 84, 90, 96
Depth: 12, 18, 21, 24 (std)

NTK

HCTBS HC Tall Bookshelf

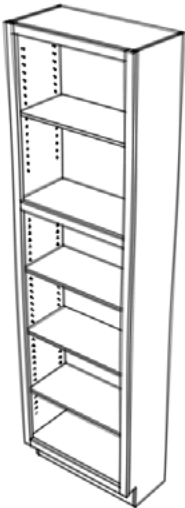

- Color matching interior
- 5.5" toe kick

Width: 12, 15, 18, 24, 27,
30, 33, 36
Height: 84, 90, 96
Depth: 12 (std), 18, 21, 24

1/2" Panels

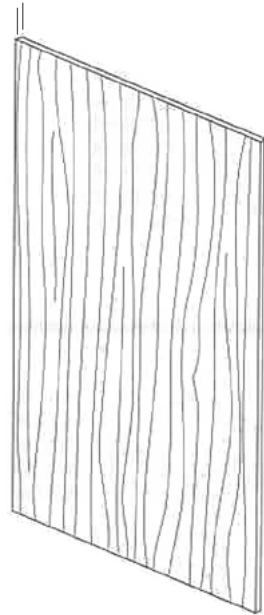

	1/2" Paper	3/4" Veneer	Actual Size
Base	EP2434 - Paper	EP2434 - Veneer	24-1/8"W x 34-1/2"H
Base Depth Vanity	EP2431 - Paper	EP2431 - Veneer	24-1/8"W x 31-1/2"H
Vanity	EP2131 - Paper	EP2131 - Veneer	21-1/8"W x 31-1/2"H
Vanity Depth Base	EP2124 - Paper	EP2134 - Veneer	21-1/8"W x 34-1/2"H
HC Base	EP2432 - Paper	EP2432 - Veneer	24-1/8"W x 32-1/2"H
84" Tall Base	EP2484 - Paper	EP2484 - Veneer	24-1/8"W x 84"H
90" Tall Base	EP2490 - Paper	EP2490 - Veneer	24-1/8"W x 90"H
96" Tall Base	EP2496 - Paper	EP2496 - Veneer	24-1/8"W x 96"H
84" Tall Vanity Depth	EP2184 - Paper	EP2184 - Veneer	21-1/8"W x 84"H
90" Tall Vanity Depth	EP2190 - Paper	EP2190 - Veneer	21-1/8"W x 90"H
96" Tall Vanity Depth	EP2196 - Paper	EP2196 - Veneer	21-1/8"W x 96"H
48" Wide Base Height	EP4834 - Paper	EP4834 - Veneer	48"W x 34-1/2"H
48" Wide Vanity Height	EP4831 - Paper	EP4831 - Veneer	48"W x 31-1/2"H
1/2 Sheet	EP4848 - Paper	EP4848 - Veneer	48"W x 48"H
Full Sheet	EP4896 - Paper	EP4896 - Veneer	48"W x 96"H

⚠ Grain pattern runs vertical and each panel is banded on front and back edges

Return Panels

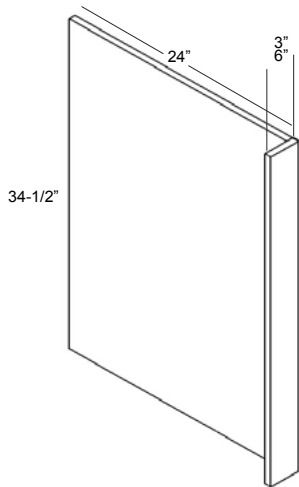

	1/2" Return w/ Veneer Front	3/4" Solid	Actual Size
Base 3" Front DW End Panel	BRP3	BRP3 - Solid	3"W x 34-1/2"H x 24-1/8"D
Base 6" Front DW End Panel	BRP6	BRP6 - Solid	6"W x 34-1/2"H x 24-1/8"D
Base 9" Front DW End Panel	BRP9	N/A	9"W x 34-1/2"H x 24-1/8"D
Base Depth Vanity 3" Front	VRP3 - 24D	VRP3 - Solid - 24D	3"W x 31-1/2"H x 24-1/8"D
Base Depth Vanity 6" Front	VRP6 - 24D	VRP6 - Solid - 24D	6"W x 31-1/2"H x 24-1/8"D
Base Depth Vanity 9" Front	VRP9 - 24D	N/A	9"W x 31-1/2"H x 24-1/8"D
Vanity 3" Front	VRP3	VRP3 - Solid	3"W x 31-1/2"H x 24-1/8"D
Vanity 6" Front	VRP6	VRP6 - Solid	6"W x 31-1/2"H x 24-1/8"D
Vanity 9" Front	VRP9	N/A	9"W x 31-1/2"H x 24-1/8"D
Vanity Depth Base 3" Front	BRP3 - 21D	BRP3 - Solid - 21D	3"W x 34-1/2"H x 24-1/8"D
Vanity Depth Base 6" Front	BRP6 - 21D	BRP6 - Solid - 21D	6"W x 34-1/2"H x 24-1/8"D
Vanity Depth Base 9" Front	BRP9 - 21D	N/A	9"W x 34-1/2"H x 24-1/8"D
HC Base 3" Front	HCBRP3	HCBRP3 - Solid	3"W x 32-1/2"H x 24-1/8"D
HC Base 6" Front	HCBRP6	HCBRP6 - Solid	6"W x 32-1/2"H x 24-1/8"D
HC Base 9" Front	HCBRP9	N/A	9"W x 32-1/2"H x 24-1/8"D
HC Vanity 3" Front	HCBRP3 - 21D	HCVRP3 - Solid	3"W x 32-1/2"H x 21-1/8"D
HC Vanity 6" Front	HCBRP6 - 21D	HCVRP6 - Solid	6"W x 32-1/2"H x 21-1/8"D
HC Vanity 9" Front	HCBRP9 - 21D	N/A	9"W x 32-1/2"H x 21-1/8"D
84" Tall Base Depth 3" Front	TRP384	TRP384 - Solid	3"W x 84"H x 24-1/8"D
90" Tall Base Depth 3" Front	TRP390	TRP390 - Solid	6"W x 90"H x 24-1/8"D
96" Tall Base Depth 3" Front	TRP396	TRP396 - Solid	9"W x 96"H x 24-1/2"D
84" Tall Vanity Depth 3" Front	TRP384 - 21 Deep	TRP384 - Solid - 21D	3"W x 84"H x 21-1/2"D
90" Tall Vanity Depth 3" Front	TRP390 - 21 Deep	TRP390 - Solid - 21D	3"W x 90"H x 21-1/2"D
96" Tall Vanity Depth 3" Front	TRP396 - 21 Deep	TRP396 - Solid - 21D	3"W x 96"H x 21-1/8"D

⚠ Dishwasher End Panel shown - order as a BRP

End Skin

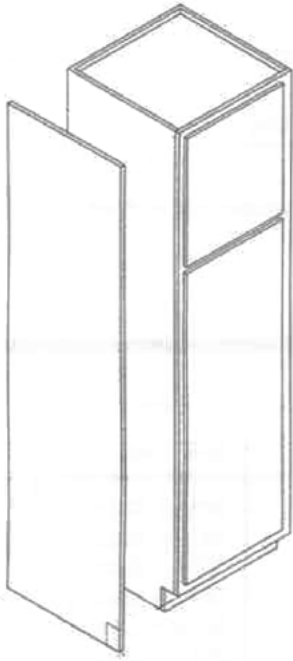

A This application depicts a skin applied to a Pantry Cabinet

	1/8" Paper	3/16" Veneer	Actual Size
Base Cabinet	SK2434 - Paper	SK2434 - Veneer	23-3/8"W x 34-1/2"H
Base Depth Vanity	SK2431 - Paper	SK2431 - Veneer	23-3/8" x 31-1/2"H
Vanity Cabinet	SK2131 - Paper	SK2131 - Veneer	20-3/8"W x 31-1/2"H
Vanity Depth Base	SK2134 - Paper	SK2134 - Veneer	20-3/8"W x 34-1/2"H
HC Base Cabinet	SK2432 - Paper	SK2432 - Veneer	23-3/8"W x 32-1/2"H
HC Vanity Cabinet	SK2132 - Paper	SK2132 - Veneer	20-3/8"W x 32-1/2"H
12" Tall Wall Cabinet	SK1212 - Paper	SK1212 - Veneer	11-1/4"W x 12"H
15" Tall Wall Cabinet	SK1215 - Paper	SK1215 - Veneer	11-1/4"W x 15"H
18" Tall Wall Cabinet	SK1218 - Paper	SK1218 - Veneer	11-1/4"W x 18"H
24" Tall Wall Cabinet	SK1224 - Paper	SK1224 - Veneer	11-1/4"W x 24"H
30" Tall Wall Cabinet	SK1230 - Paper	SK1230 - Veneer	11-1/4"W x 30"H
36" Tall Wall Cabinet	SK1236 - Paper	SK1236 - Veneer	11-1/4"W x 36"H
42" Tall Wall Cabinet	SK1242 - Paper	SK1242 - Veneer	11-1/4"W x 42"H
84" Tall Pantry	SK2484 - Paper	SK2484 - Veneer	23-3/8"W x 84"H
90" Tall Pantry	SK2490 - Paper	SK2490 - Veneer	23-3/8"W x 90"H
96" Tall Pantry	SK2496 - Paper	SK2496 - Veneer	23-3/8"W x 96"H
84" Tall Linen	SK2184 - Paper	SK2184 - Veneer	20-3/8"W x 84"H
90" Tall Linen	SK2190 - Paper	SK2190 - Veneer	20-3/8"W x 90"H
96" Tall Linen	SK2196 - Paper	SK2196 - Veneer	20-3/8"W x 96"H
48" Wide Base Skin	SK4834 - Paper	SK4834 - Veneer	48"W x 43-1/2"H
48" Wide Vanity Skin	SK4831 - Paper	SK4831 - Veneer	48"W x 31-1/2"H
1/2 Sheet	SK4848 - Paper	SK4848 - Veneer	48"W x 48"H
Full Sheet	SK4896 - Paper	SK4896 - Veneer	48"W x 96"H

Skirts

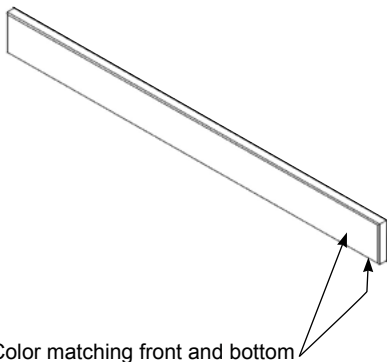

	3/4" Veneer	3/4" Solid	Actual Size
3" Wide Skirts	SKT30	SKT30 - Solid	3"W x 30"L
	SKT36	SKT36 - Solid	3"W x 36"L
	SKT42	SKT42 - Solid	3"W x 42"L
	SKT48	SKT48 - Solid	3"W x 48"L
	SKT60	SKT60 - Solid	3"W x 60"L
	SKT72	SKT72 - Solid	3"W x 72"L
	SKT84	SKT84 - Solid	3"W x 84"L
	SKT96	SKT96 - Solid	3"W x 96"L
	4" Wide Skirts	SKT30 - 4W	SKT30 - Solid - 4W
SKT36 - 4W		SKT36 - Solid - 4W	4"W x 36"L
SKT42 - 4W		SKT42 - Solid - 4W	4"W x 42"L
SKT48 - 4W		SKT48 - Solid - 4W	4"W x 48"L
SKT60 - 4W		SKT60 - Solid - 4W	4"W x 60"L
SKT72 - 4W		SKT72 - Solid - 4W	4"W x 72"L
SKT84 - 4W		SKT84 - Solid - 4W	4"W x 84"L
SKT96 - 4W		SKT96 - Solid - 4W	4"W x 96"L

Microwave Shelf

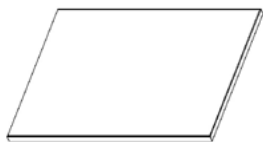

Microwave Cabinet	Cabinet Width	Shelf Name	Shelf Width
MWC24xx	24"	MWS2418	21"
MWC27xx	27"	MWS2718	24"
MWC30xx	30"	MWS3018	27"
MWC33xx	33"	MWS3318	30"
MWC36xx	36"	MWS3618	33"
MWC42xx	42"	MWS4218	36"

Fillers



	3/4" Veneer	3/4" Solid	Actual Size
30" Long	F330 F330 F630 F930	F330 - Solid F330 - Solid F630 - Solid N/A	3/4"W x 30"H 3"W x 30"H 6"W x 30"H 9"W x 30"H
36" Long	F336 F336 F636 F936	F636 - Solid F636 - Solid F636 - Solid N/A	3"W x 36"H 3"W x 36"H 6"W x 36"H 9"W x 36"H
42" Long	F342 F342 F642 F942	F342 - Solid F342 - Solid F642 - Solid N/A	3/4"W x 42"H 3"W x 42"H 6"W x 42"H 9"W x 42"H
84" Long	F384 F384 F684 F984	F384 - Solid F384 - Solid F684 - Solid N/A	3/4"W x 84"H 3"W x 84"H 6"W x 84"H 9"W x 84"H
90" Long	F390 F390 F690 F990	F390 - Solid F390 - Solid F690 - Solid N/A	3/4"W x 90"H 3"W x 90"H 6"W x 90"H 9"W x 90"H
96" Long	F396 F396 F696 F996	F396 - Solid F396 - Solid F696 - Solid N/A	3/4"W x 96"H 3"W x 96"H 6"W x 96"H 9"W x 96"H

WCP15 Wall Cabinet Corner Floor

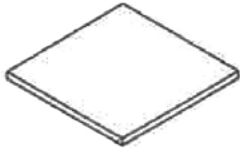

- Finish is available in natural or white

Width: 15
Height: 15
Thick: 1/2

ROS Roll Out Shelf

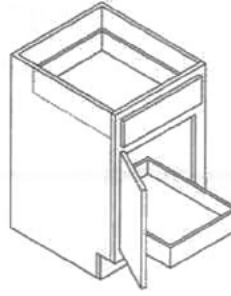

ROS12 - Fits 12" and 24" Cabinets
ROS15 - Fits 15" and 30" Cabinets
ROS18 - Fits 18" and 36" Cabinets
ROS21 - Fits 21" and 42" Cabinets
ROS24 - Fits 24" (NCM) and 48" Cabinets
ROS27 - Fits 27" (NCM) Cabinets

 Cabinet is ordered separately. Kit is applied in the field

STV Valance

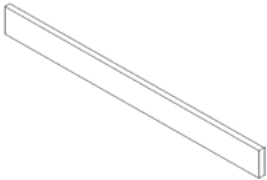

- Horizontal grain only
- Length: 12, 15, 18, 21, 24,
27, 30, 33, 36, 39,
42, 45, 48
Height: 3

DOOR Applied Doors



- Replacement door
- Specify door dimensions

TK HCTK 1/8" Toe Kick Overlay

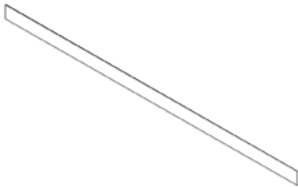

- 8 ft. length
- Color matching finish

TK-Veneer HCTK-Veneer 3/16" Veneer Toe Kick Overlay

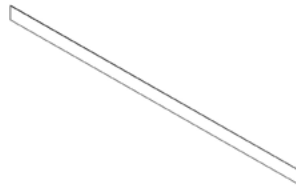

- 8 ft. length
- Color matching finish

RF Range front

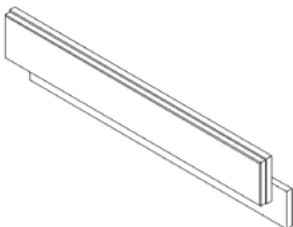

- Range front

Length: 24, 27, 30, 33, 36
Height: 4

METAL LEG Metal Furniture Foot

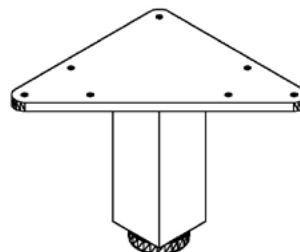

- Metal furniture foot with leveler and mounting bracket
- Brushed finish

Size: 30mm x 30mm
Height: 4-1/2

 One leg is needed to support each end of a cabinet run and one leg needed to support the joint between two cabinets.

Molding - Flat

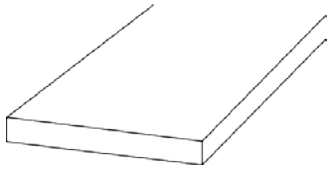

1/8" x 3/4" x 8"

Molding - Scribe

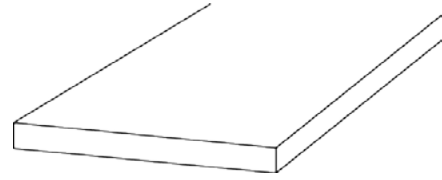

1/8" x 1-3/4" x 8"

Molding - Outside

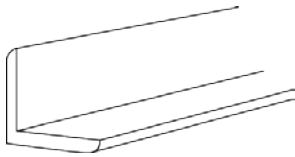

3/4" x 3/4" x 8"

Molding - Inside

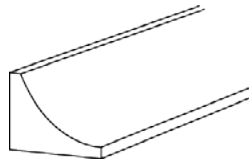

3/4" x 3/4" x 8"

Molding - Shoe

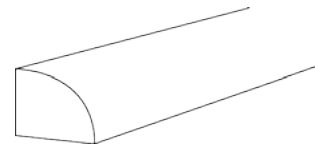

3/4" x 3/4" x 8"

Molding - Crown

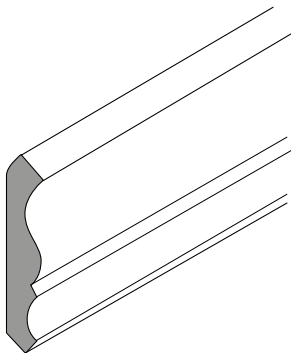

1-5/8" x 8'

Molding - Large Crown

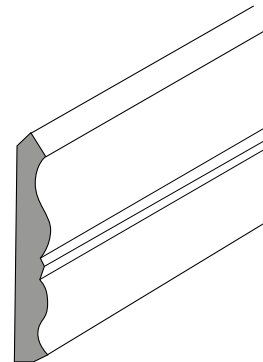

2-3/4" x 8'



©2015 LEEDO FRAMED PRODUCT LINE CATALOG 10/15

NOTICE: The framed cabinet specifications appearing herein supersede and cancel all previous sheets, supplements and addenda, and represent current manufacturing standards and procedures. Leedo Cabinetry reserves the right to make specification changes for continued product improvement. Leedo warrants all structural aspects of our products for a period of one year, excluding the results of normal wear and tear, damages that arise from misuse, and open joint lines on that occur from natural expansion and contraction of wood.

NOTE: Due to various printing limitations or monitor displays, color pictures cannot be guaranteed to exactly match the actual cabinet material.