



Leedo

We Are Building Solutions



JANUARY 2016 - EUROPEAN SPECIFICATION BOOK

2016 EURO CATALOG

TABLE OF CONTENTS

European Specifications	4
Cabinet Construction	6
Modifications Legend	7
Warranty	8
Door Style Options	9
Cabinet Care Guide	13
Base Cabinets	15
Accessible Base	20
Vanity Base	25
Hanging Vanity Base	28
Desk Base	30
Wall Cabinets	31
Tall Cabinets	33
Accessible Tall	37
Vanity Tall	38
Accessories	39

EURO PRODUCT SPECIFICATIONS

CABINET CONSTRUCTION:

- 5/8" industrial grade particleboard, conforming to ANSI 208.1 and CARB phase 2, faced with resin coated finish foil on exposed and semi exposed surfaces.
- Dowel and glue joinery of cabinet components.
- 1/8" back panel in dado, faced with resin coated finish foil on exposed surface, stapled for squareness and structural rigidity.
- 5/8" hang rails behind back panel to attach cabinets to wall.
- Integral finished ends, faced with resin coated finish foil, matching color of doors.
- Front edge of cabinet with edgeband in door-matching colors.
- 4" toe kick height, 3" deep; decorative toe kick overlays 1/8" thick with resin coated finish foil.
- Adjustable shelves 5/8" thick for cabinet width up to 27". Wider cabinets receive 3/4" thick shelf. Shelves faced both sides with resin coated finish foil in interior matching color, front edge covered with 0.018" thick composite edgeband.
- Base cabinet shelves adjustable, half cabinet depth.
- Full width drawers and false fronts on all base and sink base cabinets.

AVAILABLE OPTIONS:

- o 3/4" shelves throughout
- o Full depth shelves
- o Field applied finished ends flush with front of doors for inset cabinet look.

DOORS, DRAWER BOXES AND HARDWARE:

- Full overlay, concealed, 107 degree opening hinges, fully adjustable in 6 directions, clip-on.
- Metal drawer box, with 5/8" thick particleboard drawer bottom and back, partial roller wheel extension, white epoxy coated.
- Doors in various RTF colors as well as thermofused laminate with PVC edgebanding from Leedo's color selection.
- 1/16" bumper for a tight reveal between door and cabinet.

AVAILABLE OPTIONS:

- o Soft-close add on devices for hinges
- o Soft-close add on for metal drawer box
- o Five sided 5/8" particleboard drawer box, faced with white resin coated finish foil in interior color; with 1/8" captured drawer bottom
 - Partial extension (Note: Soft-close not available)
 - Full extension fully concealed drawer slide with integrated soft-close

EURO PRODUCT SPECIFICATIONS

STANDARD CABINET DIMENSIONS:

- Base cabinets 34½" high, 24" deep (plus door), 3" increment width, max. 39" wide
- Sink base cabinets 34½" high, 24" deep (plus door), 3" increment width, max. 48" wide
- ADA cabinets 32½" high, 24" deep (plus door), 3" increment width, max. 39" wide
- Vanity cabinets 31½" high or 34½" high, 21" deep (plus door), 3" increment width, max. 39" wide
- Vanity sink combination cabinets 31½" high or 34½" high, 21" deep (plus door), 3" increment width, max. 48" wide
- Tall cabinets 84", 90", 93" and 96" high, 24" or 26" deep, 3" increment width, max. 36" wide
- Wall cabinets 12" deep (plus door), 12" to 42" high in 3" increments, 3" increments width, max. 39" wide
- 4" high, 3" deep integrated toe kick on all base, vanity and tall cabinets
- Standard reveals 4mm between doors of adjacent cabinets, top of base cabinets and between fronts within a cabinet
- 2mm reveal of cabinet doors and drawer front to outside top and bottom of cabinet, except at top of base cabinets

STANDARD CABINET COLORS:

- White interior
- Natural interior
- Exposed bottoms and tops of wall cabinets in interior color with PVC edgebanding in interior color covering exposed bottom edges
- Front edge of cabinet PVC in complimentary color from Leedo standard offering

AVAILABLE OPTIONS:

- o Exposed bottoms of wall cabinets to have exterior color (same as finished ends)

CABINET CONSTRUCTION

BASE CABINET

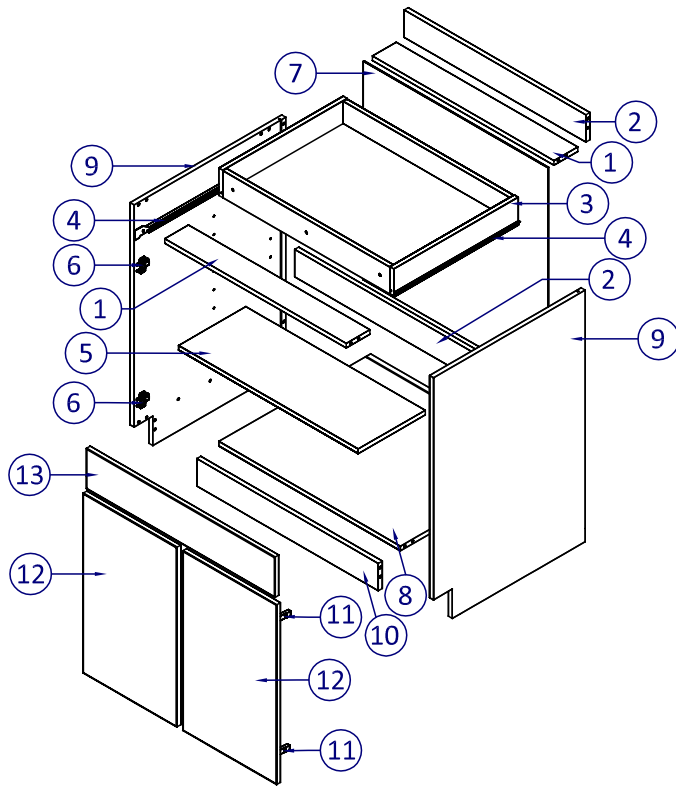

1. 5/8" stretcher
2. 5/8" nailer
3. 5/8" drawer box with 1/8" bottom particle board shown
4. Epoxy coated drawer slide
5. 5/8" half depth adjustable shelf
6. Hinge mounted base plate
7. 1/8" back panel
8. 5/8" bottom
9. 5/8" end panel
10. 5/8" toe kick
11. Hinge
12. 5/8" door
13. 5/8" drawer front

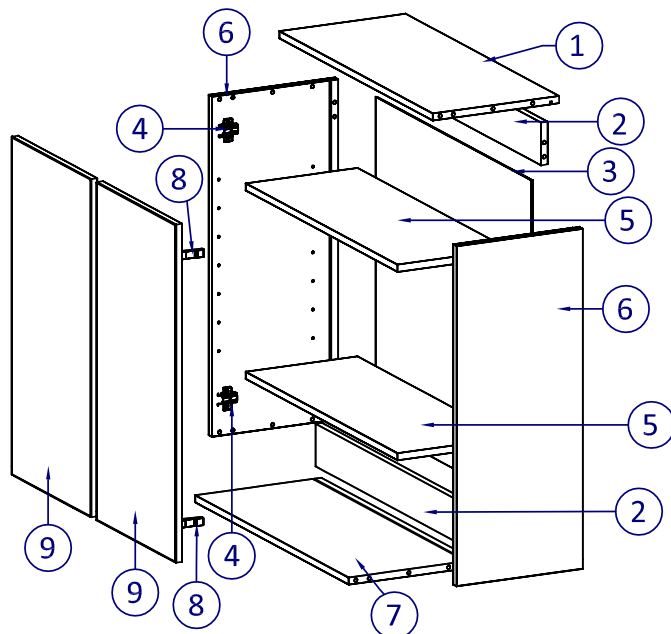

WALL CABINET

1. 5/8" top
2. 5/8" stretcher
3. 1/8" back panel
4. Hinge mounted base plate
5. 5/8" adjustable shelf
6. 5/8" end panel
7. 5/8" bottom
8. Hinge
9. 5/8" door

MODIFICATIONS LEGEND

	DESCRIPTION	STD	CODE
Toe Kick Mod TKM	Integral toe kick	●	
	No toe kick (requires alternative toe kick support, e.g. metal leg)		NTK
Drawer Mod DM	Metal drawer box, partial extension	●	MBOX500
	Metal box with soft-close glides, partial extension		MBOX500SC
	Particleboard drawer box, partial extension		PBOX500 PARTIAL
	Particleboard drawer box, full extension undermount soft close guides.		PBOX500 FULL
Shelf Mod SM	Half depth shelf	●	
	Full depth shelf		FDS
	3/4" thick full depth shelf		FDS19
Soft-Close SC DOOR	No soft-close attachment	●	
	Soft-close hinge attachment		SCD

WARRANTY INFORMATION



Thank you for selecting Leedo Cabinetry . Leedo works hard to provide an excellent product at a very competitive price. We guarantee all Leedo products for a period of ONE (1) year from the date of installation to be free of defects in materials and manufacturing. During this period we agree to replace, at no cost to the owner, any portion of our work that is found defective.

While Leedo guarantees all structural aspects of our products for a period of one year, the following exclusions do apply:

- Due to the naturally occurring variations in wood, we do not guarantee uniformity of color, tone or grain pattern; nor do we guarantee that stain or finish colors will be free of minor inconsistencies caused by natural variations in pigments and materials.
- Damage caused by normal wear and tear, abuse, neglect, misuse, alterations, water damage, or other environmental conditions such as exposure to extreme temperatures or humidity.
- Work done by others, including refinishing or removal of cabinets.
- Touch-ups, door and drawer adjustments, or cosmetic work.
- Color changes that may occur due to natural aging of the wood or due to exposure to either natural or artificial light.
- Discoloration or dullness in the finish or wood stain that may occur after exposure to ultraviolet light.

Leedo Manufacturing will make the final determination on any warranty-related items. Should a defect in materials or workmanship occur, excluding those noted above, Leedo maintains the right to repair or replace the product at our discretion.

TEXTURED LAMINATE

LUCERNE



Grey Pine



Weathered Oak



Texas Cypress

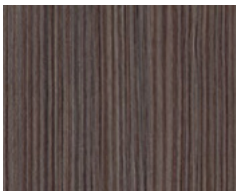

Light Teak



Midnight Teak

THERMOFOIL

COMO



GENOA



PALERMO



SOLARO



TRENTO



TRENTO 5



VARESE



VITTORIA



Door back color available in white, natural, java or cocoa pecan for all thermofoil door styles.

*Java back of door matches euro wenge and java thermofoils

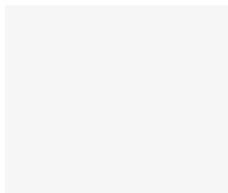

White



Snow White Gloss

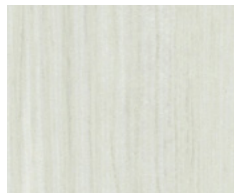

Linea White

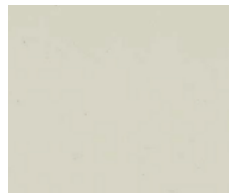

Pacific Grey

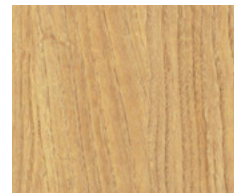

Western Wheat

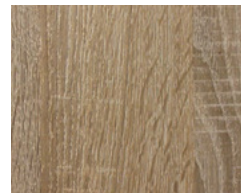

Vintage Grey

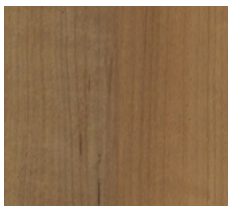

Driftwood

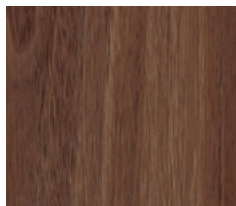

Cocoa Pecan

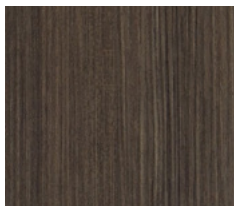

Olivewood



Euro Wenge



Java

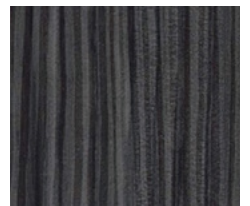

Linea Black

TRUTOUCH

LUGANO



White Tusk



Grey Cashmere



Obsidian Ash



Toffee

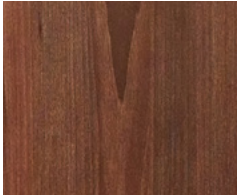

Pecan



Chestnut

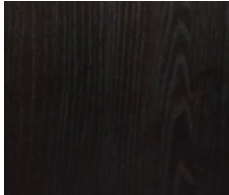

Espresso

SMOOTH LAMINATE

ASCONA

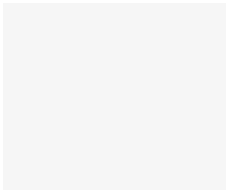

White

CABINET CARE GUIDE

A soft cotton cloth dampened with warm water is usually sufficient to clean your cabinets. If more thorough cleaning is required, use on the following cleaning solutions:

- A mixture of dish-washing liquid and warm water.
- A mild all-purpose cleaner. Make sure it does not contain ammonia, silicone, or acid.

Use the mildest cleaning solution on that will successfully clean your cabinets. Stronger products may damage or discolor your cabinet finish and are not recommended.

After cleaning, wipe all surfaces with a clean, damp cloth. Dry immediately, using another soft, clean cloth.

Spills

Clean spills immediately. Prolonged exposure to spills, including food, water or other liquids, or grease spills can cause permanent discoloration or damage to your cabinet's finish.

Cleaning Product to Avoid

- Harsh chemicals including ammonia and bleach.
- Abrasive cleaning products such as tub and sink cleaners scouring powder, scouring pads, or steel wool.
- Sponges or dish clothes. They may contain particles that could scratch your cabinets, or they may contain food and oil residue.
- Solvent-based or petroleum-based products such as mineral spirits, nail-polish removers or paint thinners.
- Silicone-based cleaning, waxing or polishing products.

Regular Dusting

Use a clean, soft, lint-free cotton cloth for regular dusting. Packaged dusting sheets are not required or recommended. Do not use pre-moistened dusting sheets or aerosol products specified for dusting.

Waxing and Polishing

Waxing is not required or recommended. Over time, waxing and polishing compounds may build up on the surface of your cabinets and cause a hazy, streaky or yellowed appearance.



Hanover West University



Fenwick Apartments



Camden South Capitol

CABINET DEPTH:
24 (STD), 21
DRAWER DEPTH:
20
HEIGHT:
34-1/2

DOORS:

- 09-24W Single Door
Specify Hinge L/R
- 24-39W Double Door
- 3-inch increments

CODE TEMPLATE:

CODE: B
WIDTH: 15
HINGE: L
DEPTH: 21

} B15-L-21D*
**Non std depth added to code*

EXAMPLES:
B15-L, B24-L/R, B27, B15-L-21D, B27-21D

BASE CABINETS

B Base Single Door and Drawer

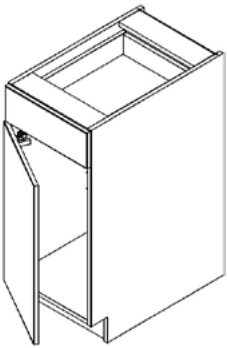

Width: 9, 12, 15, 18, 21, 24
Depth: 21, 24
Shelves: 1 Adj. half depth

TKM DM SM SC

B Base Single Drawer and Double Door

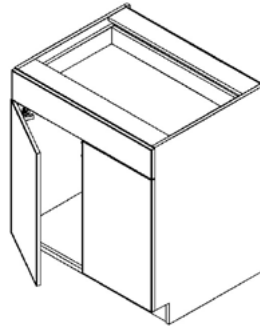

Width: 24, 27, 30, 33, 36, 39
Depth: 21, 24
Shelves: 1 Adj. half depth

TKM DM SM SC

BFHD Base Full Height Single Door

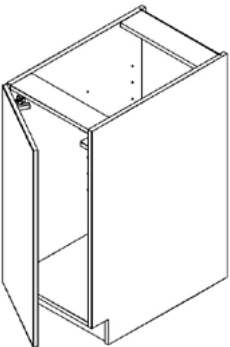

Width: 9, 12, 15, 18, 21, 24
Depth: 12, 15, 18, 21, 24
Shelves: 1 Adj. half depth

TKM SM SC

BFHD Base Full Height Double Door

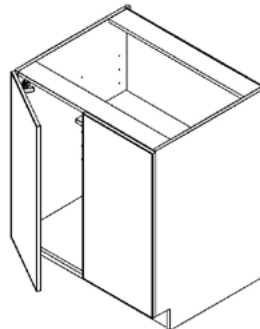

Width: 24, 27, 30, 33, 36, 39
Depth: 12, 15, 18, 21, 24
Shelves: 1 Adj. half depth

TKM SM SC

D3B Drawer 3 Base

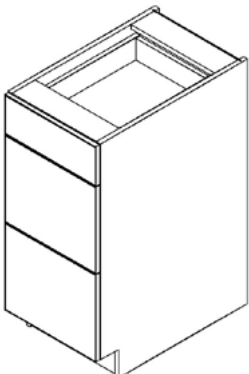

- One top drawer
- Two equal size lower drawers

Width: 9, 12, 15, 18, 21,
24, 27, 30, 33, 36, 39
Depth: 21, 24

TKM DM

D4B Drawer 4 Base

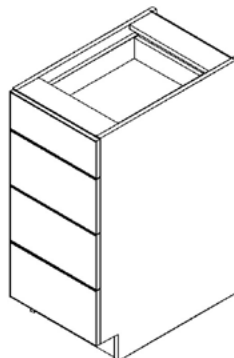

- One top drawer
- Three equal sized lower drawers

Width: 9, 12, 15, 18, 21,
24, 27, 30, 33, 36, 39
Depth: 21, 24

TKM DM

D4BF Drawer 4 Base Bottom Tall

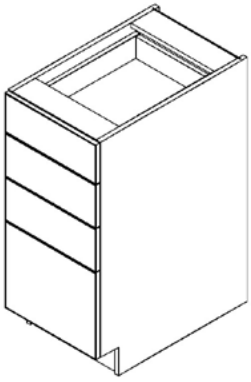

- One top drawer
- Two equal size middle drawers
- One lower drawer

Width: 9, 12, 15, 18, 21, 24,
27, 30, 33, 36, 39
Depth: 21, 24

TKM DM

D5B Drawer 5 Base

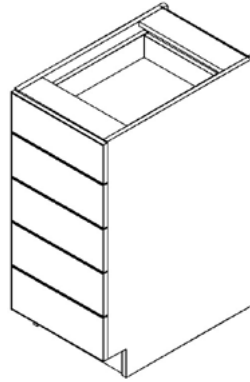

- One top drawers
- Four equal size lower drawers

Width: 9, 12, 15, 18, 21, 24,
27, 30, 33, 36, 39
Depth: 21, 24

TKM DM

BROW Base w/ Roll Out Work Surface

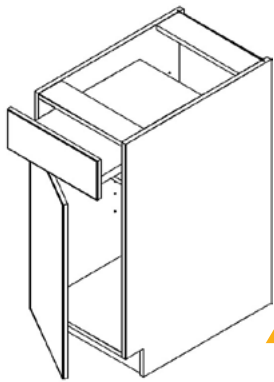

- Roll out work surface instead of top drawer

Width: 9, 12, 15, 18, 21, 24
Depth: 21, 24

TKM SC

⚠ Work surface in interior color only

BROW Base w/ Roll Out Work Surface

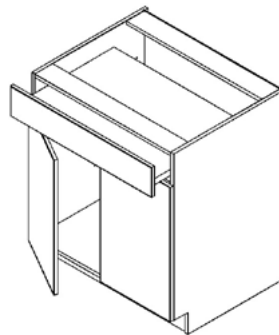

- Roll out work surface instead of top drawer
- Two doors

Width: 24, 27, 30, 33, 36, 39
Depth: 21, 24

TKM SC

⚠ Work surface in interior color only

SB Sink Base Single Door and False Front

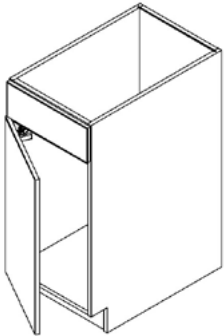

Width: 12, 15, 18, 21, 24
Depth: 12, 15, 18, 21, 24

TKM SC

SB Sink Base Double Door and False Front

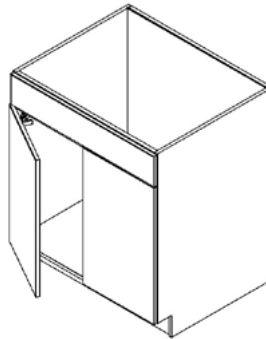

Width: 24, 27, 30, 33, 36, 39,
42, 45, 48
Depth: 12, 15, 18, 21, 24

TKM SC

SBFHD Sink Base w/ Full Height Door

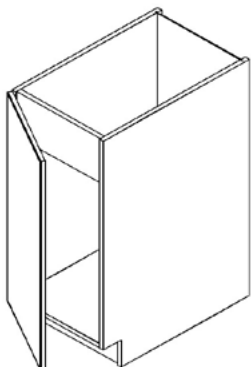

Width: 12, 15, 18, 21, 24
Depth: 12, 15, 18, 21, 24

TKM SC

SBFHROS Sink Base w/ Single FHD and Roll Out Shelf

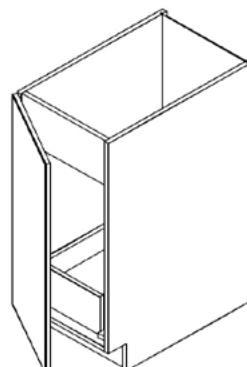

Width: 12, 15, 18, 21, 24
Depth: 21, 24

TKM SC

⚠ Roll out shelf is particleboard with full extension soft-close glides, regardless of selected drawer style

SBFHD Sink Base w/ Double FHDs

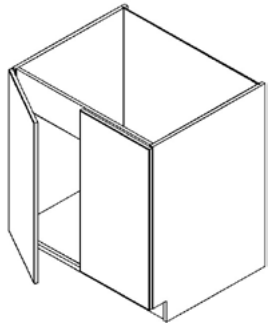

Width: 24, 27, 30, 33, 36,
39, 42, 45, 48
Depth: 12, 15, 18, 21, 24

TKM SC

SBFHDROS Sink Base w/ 2 FHDs and Roll Out Shelf

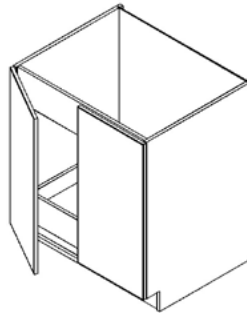

Width: 24, 27, 30, 33, 36,
39, 42, 45, 48
Depth: 21, 24

TKM SC

! Roll out shelf is particleboard with full extension soft-close glides, regardless of selected drawer style

BRB Base Removable Bottom

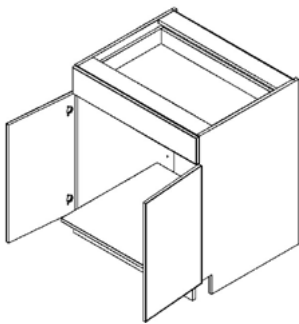

- Two doors
- One drawer

Width: 31-1/2, 33, 36, 39
Depth: 21, 24

DM SC

SBRBFHD Sink Base Removable Bottom FHD (No Baffle Option Available)

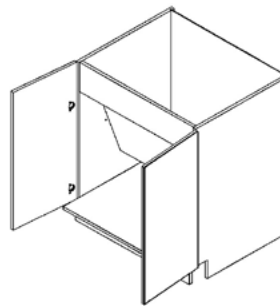

- Two full height doors

Width: 31-1/2, 33, 36, 39,
42
Depth: 21, 24

SC

SBRB Sink Base Removable Bottom (No Baffle Option Available)

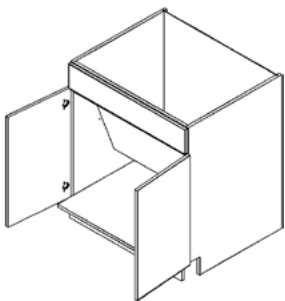

- One false front
- Two doors

Width: 31-1/2, 33, 36, 39, 42
Depth: 21, 24

SC

CSB Combo Sink Base

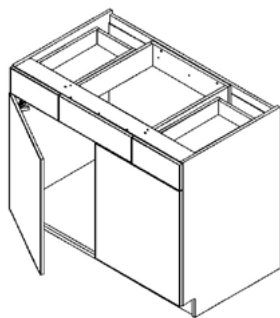

- One false front
- Two drawers
- Two doors

Width: 39, 42, 45, 48
Depth: 21, 24

DM SC

SB1DR Sink Base Single Drawer

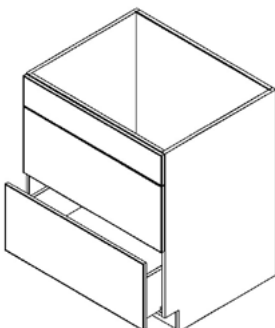

- Two false fronts

Width: 9, 12, 15, 18, 21, 24,
27, 30, 33, 36, 39
Depth: 21, 24

DM SC

SB2DR Sink Base Double Drawers

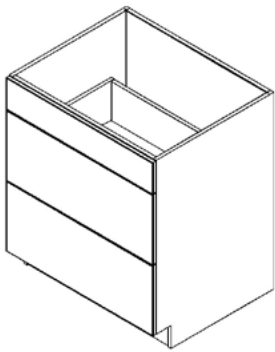

- One false front
- If used under sink, drawer box may interfere with plumbing

Width: 9, 12, 15, 18, 21, 24,
27, 30, 33, 36, 39
Depth: 21, 24

DM SC

BOD Base Oven Single Drawer

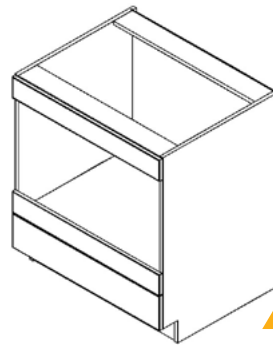

Width: 27, 30
Depth: 24

⚠ Requires appliance trim kit to hide unfinished interior

BO2D Base Oven w/ 2 Drawers

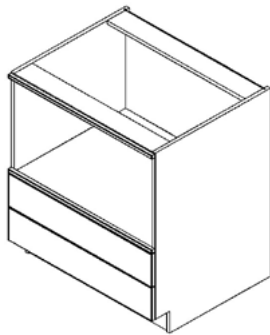

- Two drawer

Width: 27, 30
Depth: 24

⚠ Requires appliance trim kit to hide unfinished interior

BOC Base Oven Cabinet

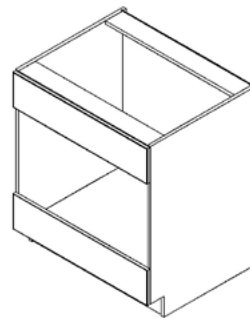

- Oven Base

Width: 27, 30
Depth: 24

⚠ Requires appliance trim kit to hide unfinished interior

ERB Easy Reach Base

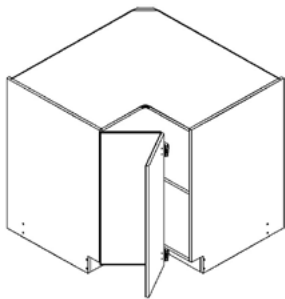

Width: 33, 36
Depth: 21, 24

**BBC##R
BBC##L Blind Base Corner-Single Door**

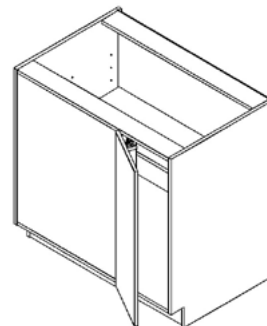

Width: 12, 15, 18, 21, 24
Depth: 24

⚠ Requires overlay filler (not included)

**BBCR
BBCL Blind Base Corner-Double Door**

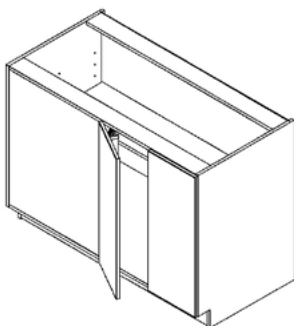

Width: 24
Depth: 24

⚠ Requires overlay filler (not included)

BBS Base Bookshelf

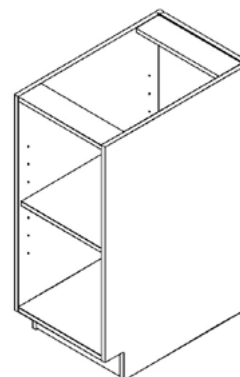

- Color matching interior

Width: 9, 12, 15, 18, 21, 24,
27, 30
Depth: 12, 15, 18, 21, 24

TKM SC

BTD Base Tray w/ Vertical Dividers

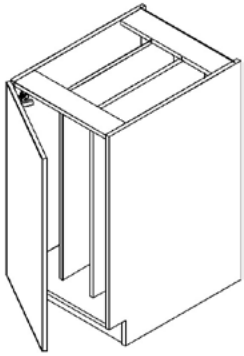

Width: 12, 15, 18, 21
Depth: 21, 24

TKM

BDTCP Base Double Trash Can Pull Out

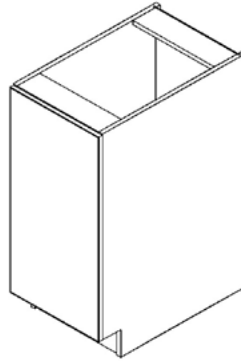

Width: 18, 21, 24
Depth: 24

TKM

 Double trash can hardware is mounted to bottom and pulls out independent of door swing

BWR Base Wine Rack

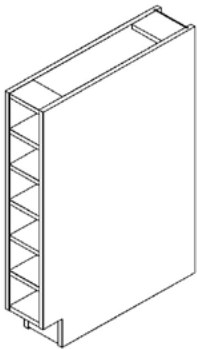

- Single column
- Fixed dividers
- Color matching interior

Width: 6
Depth: 12, 21, 24

TKM

 Internal cubby dimension:
4-3/4W x 4-5/16H

UFAS-IO UFAS Removable Sink Insert

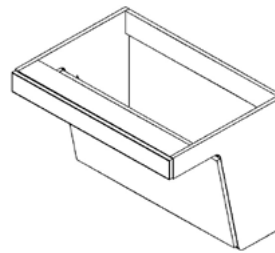

- Removable sink insert

Width: 24, 27, 30, 33, 36,
39, 42, 45, 48
Depth: 21, 24

PD Pencil Drawer

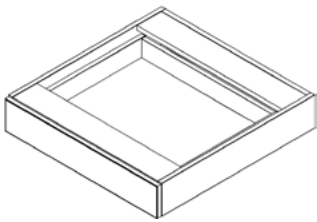

- 4" high pencil drawer
- Width: 9, 12, 15, 18, 21, 24,
27, 30, 33, 36, 39
Depth: 21, 24

 Particleboard box drawer with partial extension slides, regardless of selected drawer style

DS Drawer Skirt

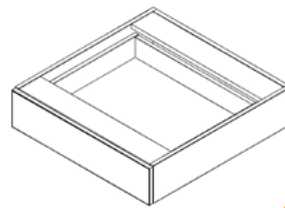

- 5-1/2" high drawer skirt
- Width: 9, 12, 15, 18, 21, 24,
27, 30, 33, 36, 39
Depth: 21, 24

 Matches top drawer height of base cabinets

BWS Base Window Seat

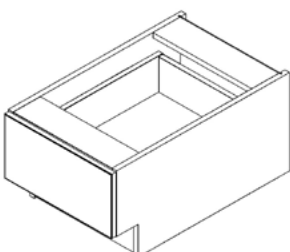

- One drawer
- Height: 12, 24
Width: 9, 12, 15, 18, 21,
24, 27, 30, 33
Depth: 21, 24

CABINET DEPTH:
24 (STD), 21
DRAWER DEPTH:
20
HEIGHT:
32-1/2

DOORS:

- 09-24W Single Door
Specify Hinge L/R
- 24-39W Double Door
- 3-inch increments

CODE TEMPLATE:

CODE: HCB
WIDTH: 15
HINGE: L
DEPTH: 21

} HCB15-L-21D*
**Non std depth added to code*

EXAMPLES:

HCB15-L, HCB24-L/R, HCB27, HCB15-L-21D, HCB27-21D

ACCESSIBLE CABINETS

HCB HC Base Single Door

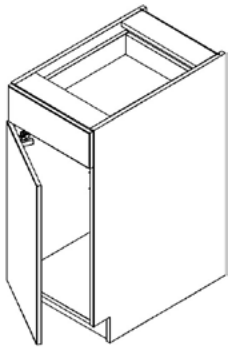

- Specify hinge L/R

Width: 9, 12, 15, 18, 21, 24
Depth: 21, 24

TKM DM SM SC

HCB HC Base Double Door

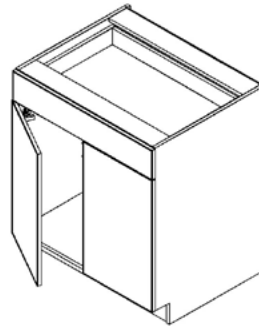

- Two doors w/ one drawer

Width: 24, 27, 30, 33, 36, 39
Depth: 21, 24

TKM DM SM SC

HCBFHD HC Base Full Height Door

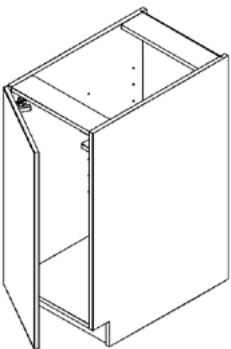

- Specify hinge L/R

Width: 9, 12, 15, 18, 21, 24
Depth: 12, 15, 18, 21, 24

TKM SC

HCBFHD HC Base Full Height Double Door

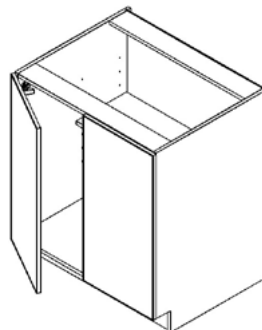

- Two doors

Width: 24, 27, 30, 33, 36, 39
Depth: 12, 15, 18, 21, 24

TKM SC

HCD3B HC Drawer 3 Base

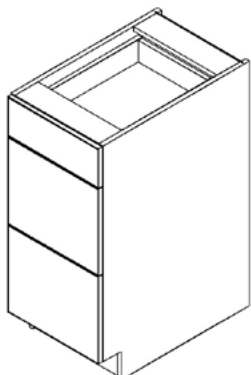

- One top drawer
- Two equal size lower drawers

Width: 9, 12, 15, 18, 21, 24, 27, 30, 33, 36, 39
Depth: 21, 24

TKM DM

HCD4B HC Drawer 4 Base

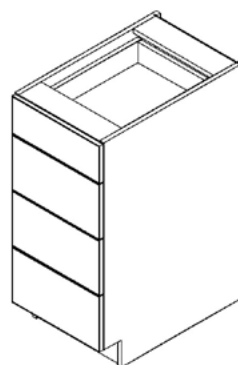

- One top drawer
- Three equal size middle drawers

Width: 9, 12, 15, 18, 21, 24, 27, 30, 33, 36, 39
Depth: 21, 24

TKM DM

HCD4BF HC Drawer 4 Base Bottom Tall

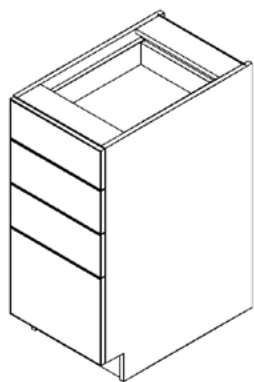

- One top drawer
- Two equal size middle drawers
- One lower drawer

Width: 9, 12, 15, 18, 21,
24, 27, 30, 33, 36, 39
Depth: 21, 24

TKM DM

HCBROW HCB w/ Roll Out Work Surface

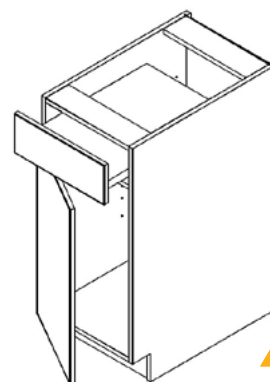

- Roll out work surface instead of top drawer

Width: 9, 12, 15, 18, 21, 24
Depth: 21, 24

TKM SC

⚠ Work surface in interior color only

HCBROW HC Base w/ Roll Out Work Surface

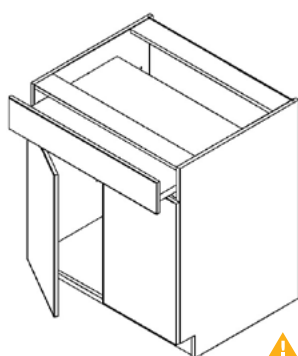

- Roll out work surface instead of top drawer
- Two doors

Width: 24, 27, 30, 33, 36, 39
Depth: 21, 24

TKM SC

⚠ Work surface in interior color only

HCBRB HC Base Removable Bottom

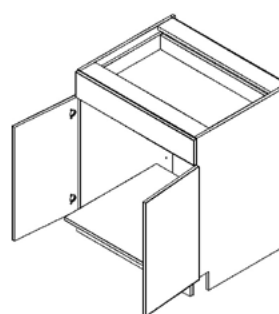

- Two doors w/ one drawer

Width: 31-1/2, 33, 36, 39
Depth: 21, 24

DM SC

⚠ Top drawer is particleboard partial extension, regardless of selected drawer style

HCSBRBFHD HC Sink Base Removable Bottom FHD (No Baffle Option Available)

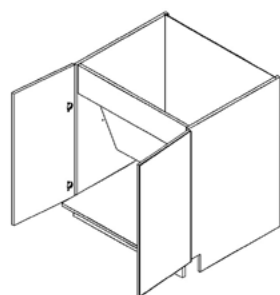

- Two full height doors

Width: 31-1/2, 33, 36, 39,
42
Depth: 21, 24

SC

HCSBRB HC Sink Base Removable Bottom (No Baffle Option Available)

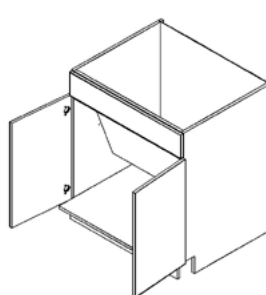

- One drawer
- Two doors

Width: 31-1/2, 33, 36, 39,
42
Depth: 21, 24

SC

HCSBFHD HC Sink Base w/ 1 FHD

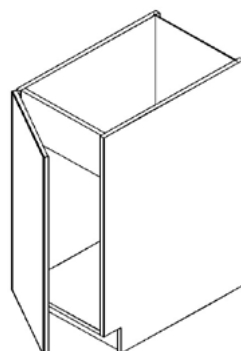

- Specify hinge L/R

Width: 12, 15, 18, 21, 24
Depth: 12, 15, 18, 21, 24

SC

HCSBFHD HC Sink Base w/ 2 FHDs

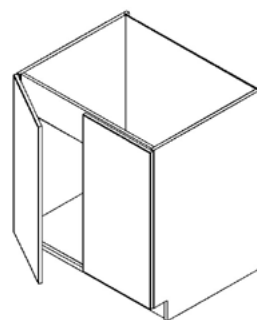

- Two full height doors

Width: 24, 27, 30, 33, 36,
39, 42, 45, 48
Depth: 12, 15, 18, 21, 24

SC

HCSBFHDROS

HC Sink Base w/ 1 FHD and Roll Out Shelf

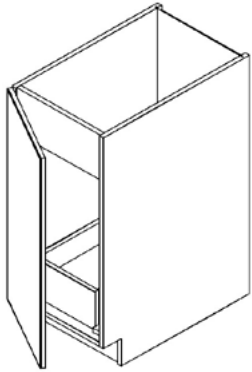

- One full height door

Width: 12, 15, 18, 21, 24
Depth: 21, 24

SC

⚠ Roll out shelf is particleboard with full extension soft-close glides regardless of selected drawer style

HCSBFHDROS

HC Sink Base w/ 2 FHDs and Roll Out Shelf

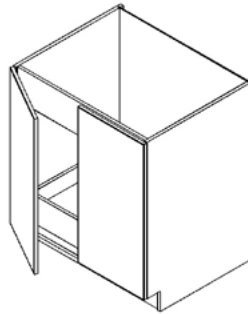

- Two full height doors

Width: 24, 27, 30, 33, 36, 39, 42, 45, 48
Depth: 21, 24

SC

⚠ Roll out shelf is particleboard with full extension soft-close glides regardless of selected drawer style

HCSB1DR

HC Sink Base 1 Drawer, 2 False Fronts

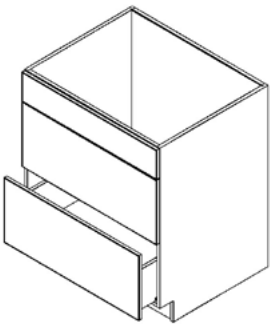

- Two false fronts

Width: 9, 12, 15, 18, 21, 24, 27, 30, 33, 36, 39
Depth: 21, 24

DM

HCSB2DR

HC Sink Base 2 Drawers, 1 False Front

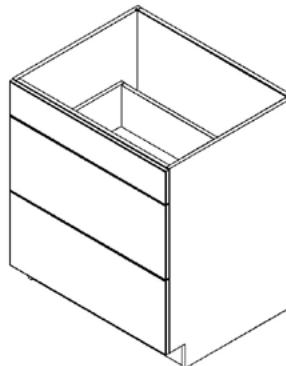

- One false front
- If used under sink, drawer box may interfere with plumbing

Width: 9, 12, 15, 18, 21, 24, 27, 30, 33, 36, 39
Depth: 21, 24

DM

HCSB

HC Sink Base 1 Door, 1 False Front

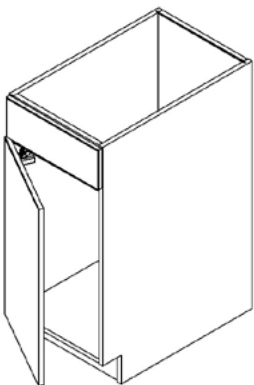

- One door
- One false front
- Specify hinge L/R

Width: 12, 15, 18, 21, 24
Depth: 12, 15, 18, 21, 24

SC

HCSB

HC Sink Base 2 Doors, 1 False Front

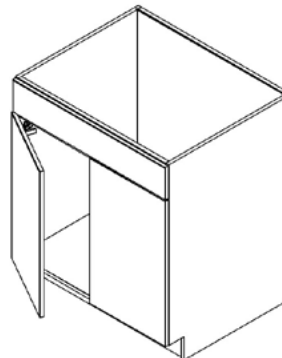

- Two doors
- One false front

Width: 24, 27, 30, 33, 36, 39, 42, 45, 48
Depth: 12, 15, 18, 21, 24

SC

HCBBC##R
HCBBC##L

**HC Blind Base Corner w/
1 Door**

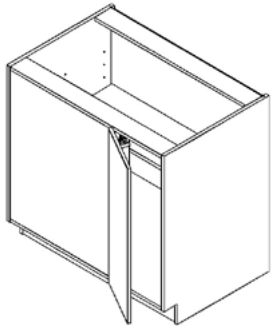

Width: 12, 15, 18, 21, 24
Depth: 24

 Requires overlay filler (not included)

HCBBCR
HCBBCL

**HC Blind Base Corner w/
2 Doors**

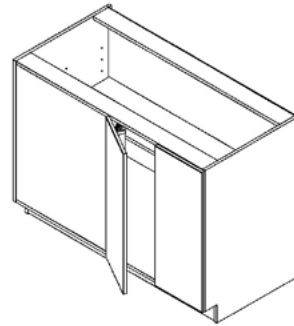

- Two doors

Width: 24
Depth: 24

 Requires overlay filler (not included)

HCCSB HC Combo Sink Base Vanity

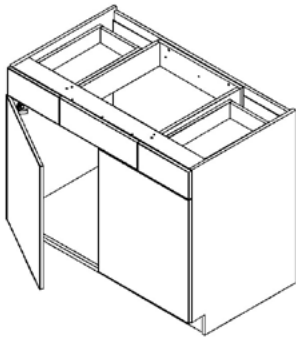

- Two doors
- Two drawers
- Center false front

Width: 39, 42, 45, 48
Depth: 24, 21

DM **SC**

HCBO2D HC Base Oven w/ 2 Drawers

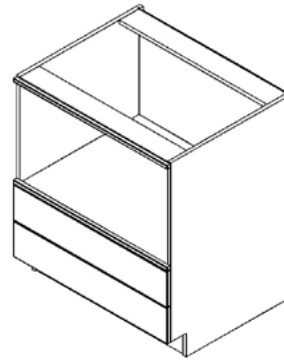

- Two drawer

Width: 27, 30
Depth: 24

 Requires appliance trim kit to hide unfinished interior

HCBOC HC Base Oven Cabinet

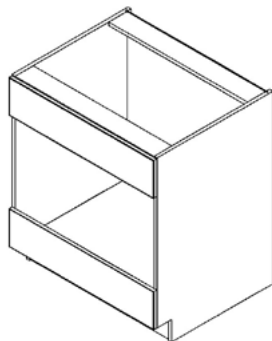

Width: 27, 30
Depth: 24

 Requires appliance trim kit to hide unfinished interior

HCBOB HC Base Oven w/ Drawer

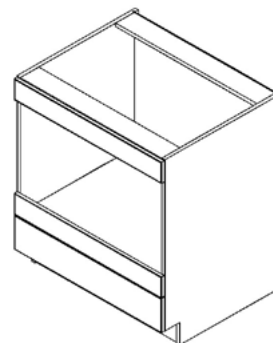

- One drawer

Width: 27, 30
Depth: 24

 Requires appliance trim kit to hide unfinished interior

HCBBS HC Base Bookshelf

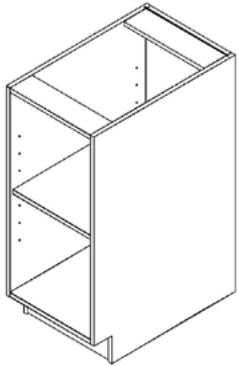

- Color matching interior

Width: 9, 12, 15, 18, 21, 24, 27, 30
 Depth: 12, 15, 18, 21, 24

TKM SM

HCBSD HC Base Tray w/ Vertical Divider(s)

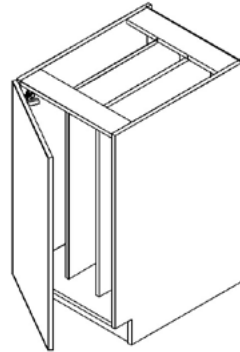

- Specify hinge L/R

Width: 12, 15, 18, 21
 Depth: 21, 24

TKM SC

HCBDTCP HC Base Double Trash Can Pull Out

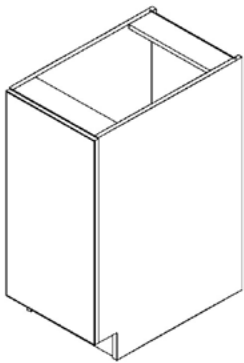

- Specify hinge L/R

Width: 18, 21, 24
 Depth: 24

TKM SC

! Double trash can hardware is mounted to bottom and pulls out independent of door

UFAS-HCSB-IO HC Removable Sink Base Insert Only

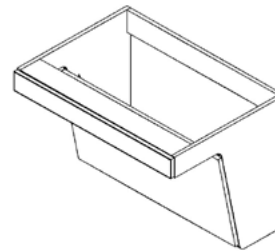

- Removable sink insert

Width: 24, 27, 30, 33, 36, 39, 42, 45, 48
 Depth: 21, 24

HCBWR HC Base Wine Rack

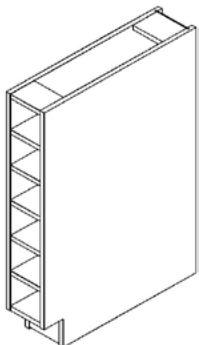

- Single column
- Fixed dividers
- Color matching interior

Width: 6
 Depth: 12, 21, 24

TKM

! Internal cubby dimension: 4-3/4W x 4-5/16H

CABINET DEPTH:

24, 21 (STD)

DRAWER DEPTH:

20

HEIGHT:

31-1/2

DOORS:

- 09-24W Single Door
Specify Hinge L/R
- 24-39W Double Door
- 3-inch increments

CODE TEMPLATE:**CODE:** VB**WIDTH:** 15**HINGE:** L**DEPTH:** 24
 VB15-L-24D*
**Non std depth
 added to code*
EXAMPLES:

VB15-L, VB24-L/R, VB27, VB15-L-24D, VB27-24D

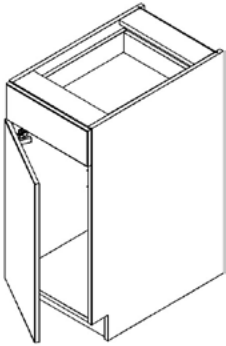
VANITY BASE CABINETS**VB** VB Single Door

- Specify hinge L/R

 Width: 9, 12, 15, 18, 21, 24
 Depth: 21, 24

TKM DM SM SC

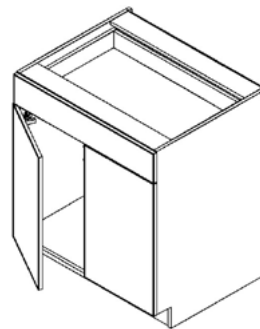
VB VB Double Door

- Two doors w/ one drawer

 Width: 24, 27, 30, 33,
 36, 39
 Depth: 21, 24

TKM DM SM SC

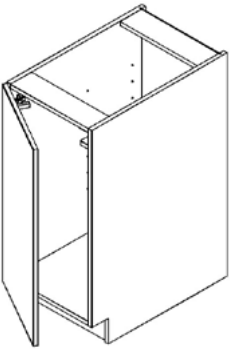
VBFHD VB Full Height Door

- Specify hinge L/R

 Width: 9, 12, 15, 18, 21, 24
 Depth: 12, 15, 18, 21, 24

TKM SM SC

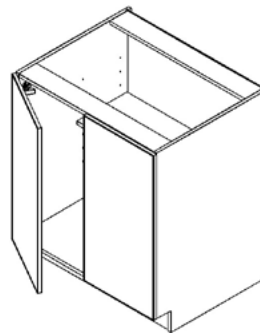
VBFHD VB Full Height Double Door

- Two doors

 Width: 24, 27, 30, 33, 36, 39
 Depth: 12, 15, 18, 21, 24

TKM SM SC

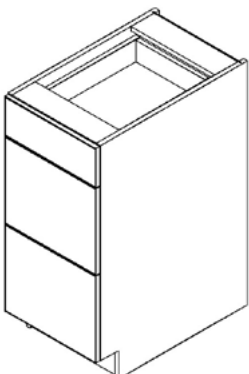
VD3B Vanity Drawer 3 Base

- One top drawer
- Two equal size lower drawers

 Width: 9, 12, 15, 18, 21,
 24, 27, 30, 33, 36, 39
 Depth: 21, 24

TKM DM

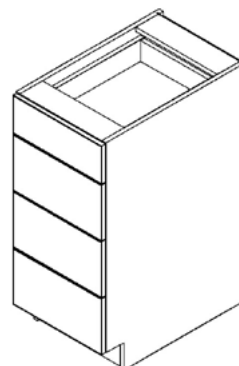
VD4B Vanity Drawer 4 Base

- One top drawer
- Three equal size lower drawers

 Width: 9, 12, 15, 18, 21,
 24, 27, 30, 33, 36, 39
 Depth: 21, 24

TKM DM

VD4BF Vanity Drawer 4 Base Bottom Tall

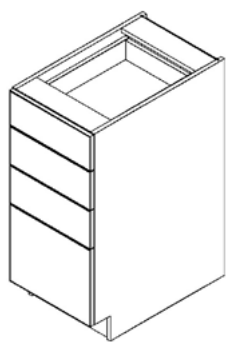

- One top drawer
- Two equal size middle drawers
- One lower drawer

Width: 9, 12, 15, 18, 21, 24, 27, 30, 33, 36, 39
 Depth: 21, 24

TKM DM

VSBFBFHD VSBFBFHD - NB

Vanity Sink Base Removable Bottom FHD

(No Baffle Option Available)

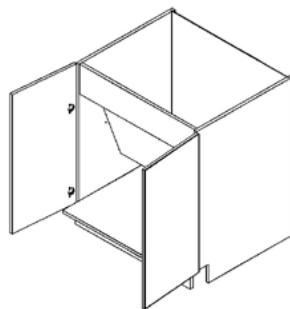

- Two full height doors

Width: 31-1/2, 33, 36, 39, 42
 Depth: 21, 24

SC

VSBFHD Vanity Sink Base w/ 1 FHD

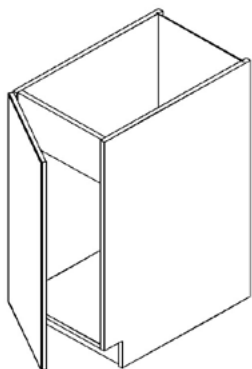

- Specify hinge L/R

Width: 12, 15, 18, 21, 24
 Depth: 12, 15, 18, 21, 24

SC

VSBFHD Vanity Sink Base w/ 2 FHDs

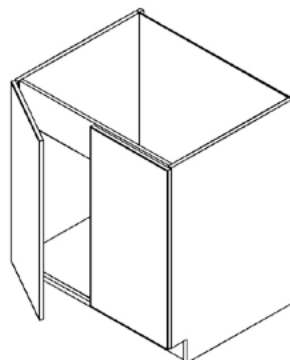

- Two full height doors

Width: 24, 27, 30, 33, 36, 39, 42, 45, 48
 Depth: 12, 15, 18, 21, 24

SC

VSBFHDROS Vanity Sink Base w/ 1 FHD and Roll Out Shelf

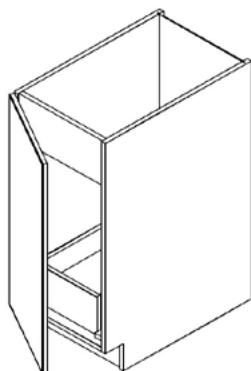

- One full height door

Width: 12, 15, 18, 21, 24
 Depth: 21, 24

SC

⚠ Roll out shelf is particleboard with full extension soft-close glides regardless of selected drawer style

VSBFHDROS Vanity Sink Base w/ 2 FHDs and Roll Out Shelf

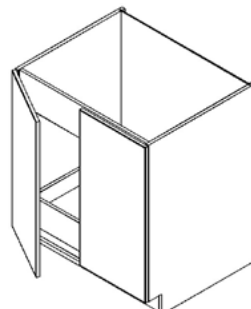

- Two full height doors

Width: 24, 27, 30, 33, 36, 39, 42, 45, 48
 Depth: 21, 24

SC

⚠ Roll out shelf is particleboard with full extension soft-close glides regardless of selected drawer style

VSB Vanity Sink Base 1 Door, 1 False Front

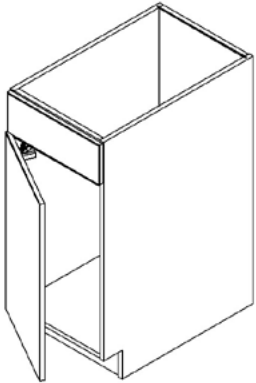

- One door
- One false front
- Specify hinge L/R

Width: 12, 15, 18, 21, 24
 Depth: 12, 15, 18, 21, 24

SC

VSB Vanity Sink Base 2 Doors, 1 False Front

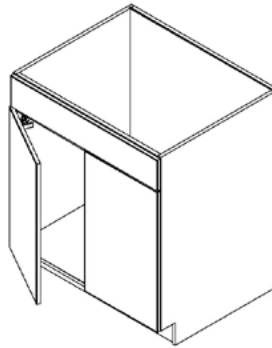

- Two doors
- One false front

Width: 24, 27, 30, 33, 36, 39,
 42, 45, 48
 Depth: 12, 15, 18, 21, 24

SC

VSB1DR Vanity Sink Base 1 Drawer, 2 False Fronts

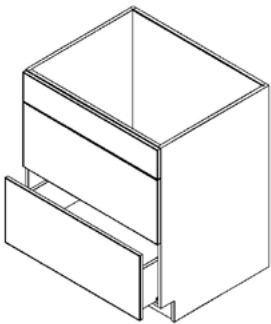

- Two false fronts

Width: 9, 12, 15, 18, 21, 24,
 27, 30, 33, 36, 39
 Depth: 21, 24

DM

VSB2DR Vanity Sink Base 2 Drawers, 1 False Front

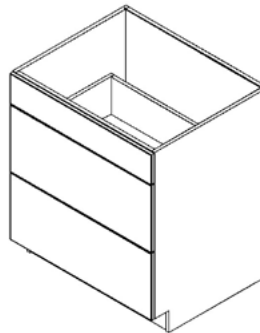

- One false front
- If used under sink, drawer box may interfere with plumbing

Width: 9, 12, 15, 18, 21, 24,
 27, 30, 33, 36, 39
 Depth: 21, 24

DM

CVSB Combo Vanity Sink Base

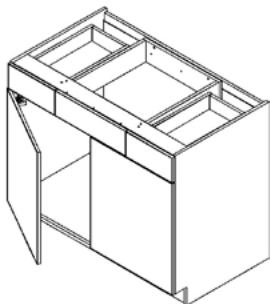

- Two doors
- Two drawers
- Center false front

Width: 39, 42, 45, 48
 Depth: 21, 24

DM SC

UFAS-VSB-IO UFAS Removable Sink Insert

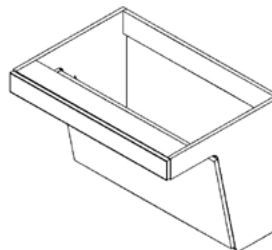

- Removable sink insert

Width: 24, 27, 30, 33, 36, 39,
 42, 45, 48
 Depth: 21, 24

CABINET DEPTH:
21
DRAWER DEPTH:
20
HEIGHT:
18, 24

DOORS:

- 9-21W Single Door
Specify Hinge L/R
- 24-36W Double Door
- 3-inch increments

CODE OUTLINE:

CODE: HV
WIDTH: 15
HEIGHT: 24
HINGE: L

} HVBFHD1524-L

EXAMPLES:

HVBFHD1218, HVD2B1224, HVBS1524,
HVSBFHD2718

HANGING VANITY CABINETS

HVBFHD HV Base Full Height Door

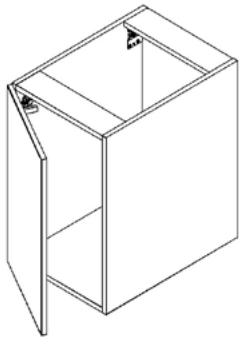

- Specify hinge L/R

Width: 9, 12, 15, 18, 21
Depth: 21
Shelves: 1 Adj. half depth

SC

HVBFHD HV Base Full Height Door

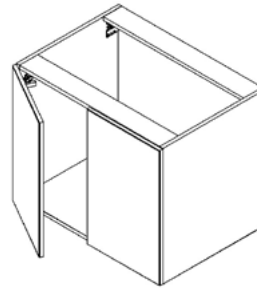

- Two doors

Width: 24, 27, 30, 33, 36
Depth: 21
Shelves: 1 Adj. half depth

SC

HVD2B HV Drawer 2 Base

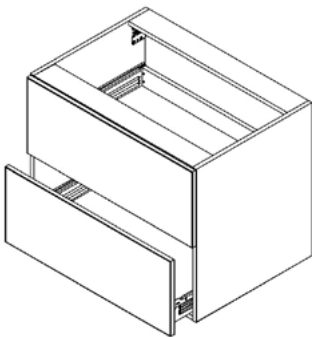

- One top false drawer
- One lower drawer

Width: 9, 12, 15, 18, 21,
24, 27, 30, 33, 36
Depth: 21

DM

HVBS HV Open Shelves

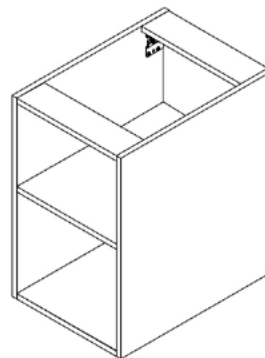

- Color matching interior

Width: 9, 12, 15, 18, 21, 24,
27, 30, 33, 36
Depth: 21

HANGING VANITY SINK CABINETS

HVSBFHD HV Sink Base Full Height Door

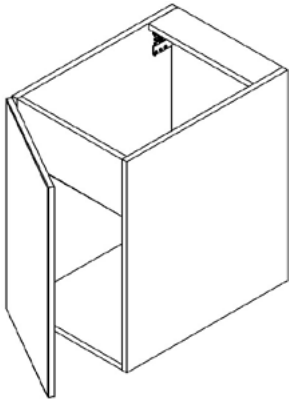

- Specify hinge L/R

Width: 18, 21
Depth: 21

SC

HVSBFHD HV Sink Base Full Height Door

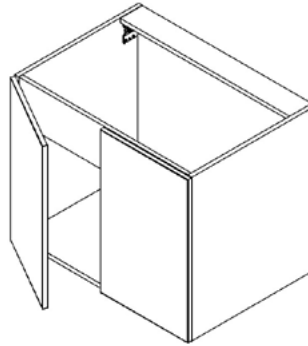

- Two doors

Width: 24, 27, 30, 33, 36
Depth: 21
Shelves: 1 Adj. half depth

SC

HVSD1B HV Sink Drawer 2 Base

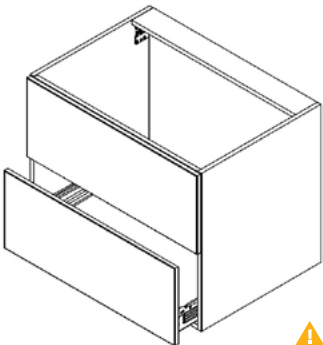

- One top false drawer
- One lower drawer

Width: 18, 21, 24, 27,
30, 33, 36
Depth: 21

DM

 *Leedo does not provide drawer cut out for p-trap and may require plumbing to clear drawer operation.*

CABINET DEPTH:
24 (STD), 21
DRAWER DEPTH:
20
HEIGHT:
28-1/2

DOORS:

- 09-24W Single Door
Specify Hinge L/R
- 24-39W Double Door
- 3-inch increments

CODE OUTLINE:

CODE: DKB
WIDTH: 15
HINGE: L
DEPTH: 21

} DKB15-L-21D*
**Non std depth added to code*

EXAMPLES:
DKB15-L, DKB24-L/R, DKB27, DKB15-L-21D, DKB27-21D

DESK BASE CABINETS

DKB DK Base Single Door

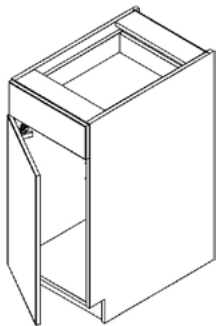

- Specify hinge L/R

Width: 9, 12, 15, 18, 21, 24
Depth: 21, 24

TKM DM SC

DKB DK Base Double Door

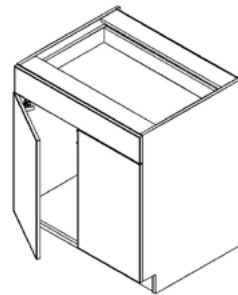

- Two doors w/ one drawer

Width: 24, 27, 30, 33, 36, 39
Depth: 21, 24

TKM DM SC

DKBFHD DK Base Full Height Door

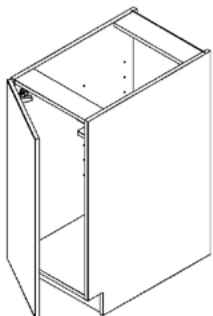

- Specify hinge L/R

Width: 9, 12, 15, 18, 21, 24
Depth: 12, 15, 18, 21, 24

TKM SC

DKBFHD DK Base Full Height Door

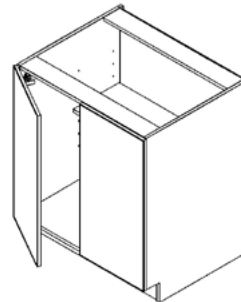

- Two doors

Width: 24, 27, 30, 33, 36, 39
Depth: 12, 15, 18, 21, 24

TKM SC

DKD3B DK Drawer 3 Base

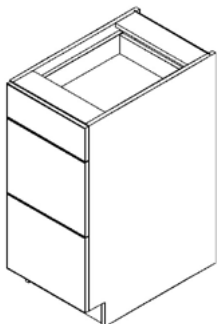

Width: 9, 12, 15, 18, 21, 24, 27, 30, 33, 36, 39
Depth: 21, 24

TKM DM

DKD4B DK Drawer 4 Base

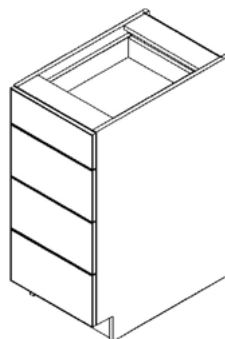

Width: 9, 12, 15, 18, 21, 24, 27, 30, 33, 36, 39
Depth: 21, 24

TKM DM

DKBBS DK Base Bookshelf

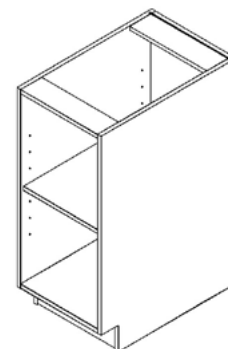

Width: 9, 12, 15, 18, 21, 24, 27, 30
Depth: 12, 15, 18, 21, 24

TKM DM

CABINET DEPTH:

15, 12 (STD)

SHELF RULE:

12 – 18" No shelves

21 – 27" 1 Shelf

30 – 39" 2 Shelves

42" 3 Shelves

DOORS:

- 09-24W Single Door
Specify Hinge L/R
- 24-39W Double Door
- 3-inch increments

CODE TEMPLATE:**CODE:** W**WIDTH:** 15**HEIGHT:** 15**HINGE:** L**DEPTH:** 15

W1530-L-15D*
*Non std depth added
to code

EXAMPLES:

W0915-L, W2430-L/R, W2715, W1515-L-15D

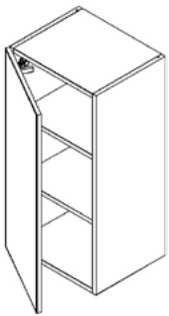
WALL CABINETS**W** Wall Single Door

- Specify hinge L/R

Width: 9, 12, 15, 18, 21, 24

Height: 12, 15, 18, 21, 24, 27,
30, 33, 36, 39, 42

Depth: 12, 15, 24 (no shelf)

SM SC

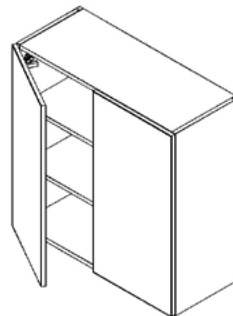
W Wall Double Door

- Two split door sections

Width: 24, 27, 30, 33, 36, 39

Height: 12, 15, 18, 21, 24,
27, 30, 33, 36, 39, 42

Depth: 12, 15, 24 (no shelf)

SM SC

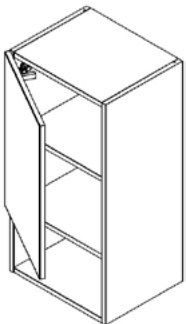
WL Wall Linen - 1 Door
over Shelf

Width: 9, 12, 15, 18, 21, 24

Height: 27, 30, 33, 36, 39, 42

Depth: 12, 15

SM SC

⚠ Shelf opening: 8-1/4H

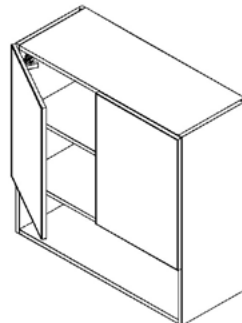
WL Wall, 2 Doors
over Shelf

Width: 24, 27, 30, 33, 36, 39

Height: 27, 30, 33, 36, 39, 42

Depth: 12, 15

SM SC

⚠ Shelf opening: 8-1/4H

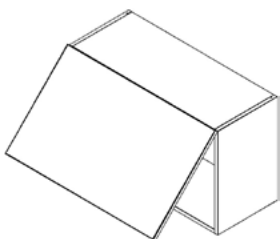
WHT Wall Hinged TopWidth: 15, 18, 21, 24, 27, 30,
33, 36, 39

Height: 15, 18, 21, 24

Depth: 12, 15

SM SC

WCUB Wall Cubby - 1 Door over Cubbies

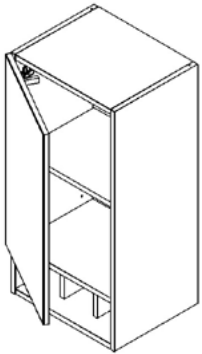

- Specify hinge L/R
- Matching interior

Width: 9, 12, 15, 18, 21, 24
 Height: 27, 30, 36, 39, 42
 Depth: 12, 15

SM SC

⚠ Internal cubby dimensions are equally spaced

WCUB Wall Cubby - 2 Doors over Cubbies

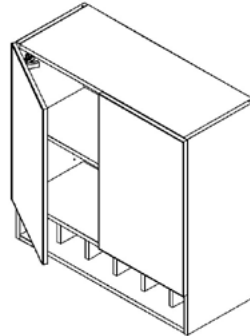

- Two split door sections
- Matching interior

Width: 24, 27, 30, 33, 36, 39
 Height: 27, 30, 36, 39, 42
 Depth: 12, 15

SM SC

⚠ Internal cubby dimensions are equally spaced

WMC Wall Microwave Cabinet

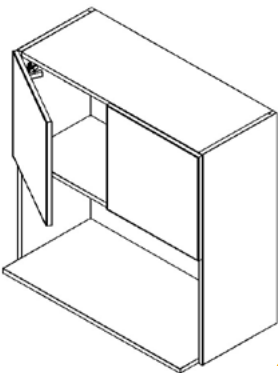

- Two split door sections
- Matching interior

Width: 24, 27, 30, 33, 36
 Height: 30, 36, 42
 Depth: 12

SC

⚠ Opening height: 14-1/16

WBCL/WBCR Wall Blind Corner 1 Door

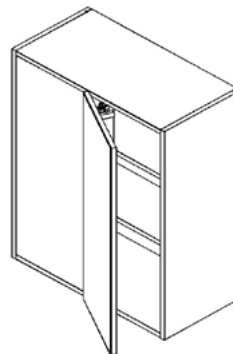

Width: 12, 15, 18, 21, 24, 27, 30, 33, 36
 Height: 24, 27, 30, 33, 36, 39, 42
 Depth: 12, 15

SM SC

⚠ Requires overlay filler (not included)

WBCL/WBCR Wall Blind Corner 2 Doors

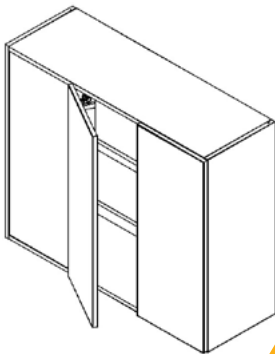

- Two split door sections

Width: 27, 30, 33, 36
 Height: 27, 30, 33, 36, 39, 42
 Depth: 12, 15

SM SC

⚠ Requires overlay filler (not included)

ERW Easy Reach Wall

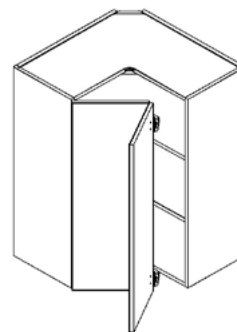

- Specify hinge L/R

Width: 24, 27
 Height: 24, 27, 30, 36, 39, 42
 Depth: 12

SM

WR Wine Rack

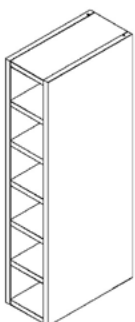

- Single column
- Fixed dividers
- Color matching interior

Width: 6
 Height: 15, 18, 24, 30, 36, 42
 Depth: 12, 15, 18, 21, 24

⚠ Internal cubby dimension:
 4-3/4W x 4-1/4H

WBS Wall Book Shelf

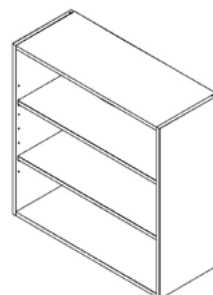

- Color matching interior

Width: 9, 12, 15, 18, 21, 24, 27, 30, 33, 36, 39
 Height: 12, 15, 18, 21, 24, 27, 30, 36, 39, 42
 Depth: 12, 15

CABINET DEPTH:

12
15
18,
21
24 (STD)
26

DOORS:

- 09-24W Single Door
Specify Hinge L/R
- 24-39W Double Door
- 3-inch increments

CODE TEMPLATE:

CODE: P
WIDTH: 15
HEIGHT: 84
HINGE: L
DEPTH: 21

P1584-L-21D*
**Non std depth added
to code*

EXAMPLES:

P1284-L, P2490-L/R, P2793, P1584-L-21D, P2790-21D

TALL CABINETS**Bottom Shelf + Top Shelf = Shelf Count**

$$\begin{array}{c} 3 + 1 = \text{Shelf Count} \\ \swarrow \quad \searrow \\ \text{Bottom} \quad \text{Top} \end{array}$$

	UC	P	KL	KLD3B	TBS	LC	LHC
84"	2 + 2	3 + 1	1 + 2	2	2 + 2	1 + 3	3
90"	2 + 2	3 + 1	1 + 2	2	2 + 2	1 + 4	3
93"	2 + 2	3 + 1	1 + 2	2	2 + 2	1 + 4	3
96"	2 + 3	3 + 2	1 + 3	3	2 + 3	1 + 4	3

Shelf count is also applicable for accessible cabinet types and does not include fixed middle shelf (if applicable).

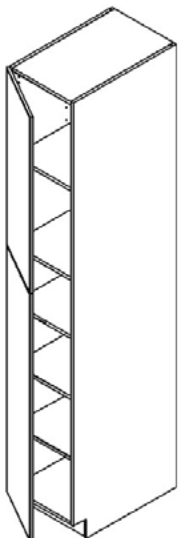
P Pantry Single Door

- Specify hinge L/R

Width: 12, 15, 18, 21, 24
Height: 84, 90, 93, 96
Depth: 12, 15, 18, 21, 24, 26

TKM SM SC

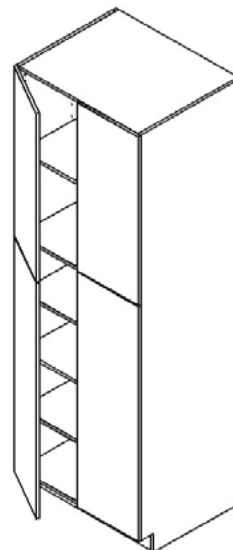
P Pantry Double Door

- Two split door sections

Width: 24, 27, 30, 36
Height: 84, 90, 93, 96
Depth: 12, 15, 18, 21, 24, 26

TKM SM SC

KL Kitchen Linen Single Door

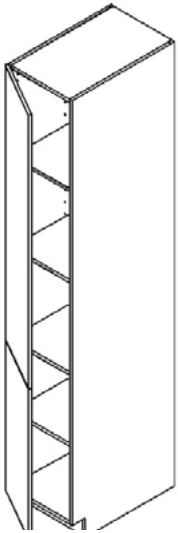

- Specify hinge L/R
- Bottom doors align with base cabinet heights

Width: 9, 12, 15, 18, 21, 24
Height: 84, 90, 93, 96
Depth: 12, 15, 18, 21, 24, 26

TKM SM SC

KL Kitchen Linen Double Door

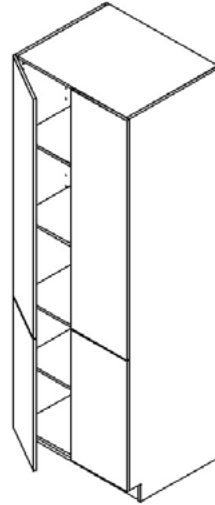

- Two split door sections
- Bottom doors align with base cabinet heights

Width: 24, 27, 30, 33, 36
Height: 84, 90, 93, 96
Depth: 12, 15, 18, 21, 24, 26

TKM SM SC

KLD3B Kitchen Linen Drawer 3 Base

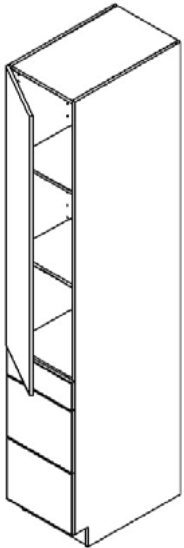

- Specify hinge L/R

Width: 9, 12, 15, 18, 21, 24
Height: 84, 90, 93, 96
Depth: 21, 24, 26

TKM DM SM SC

KLD3B Kitchen Linen Drawer 3 Base

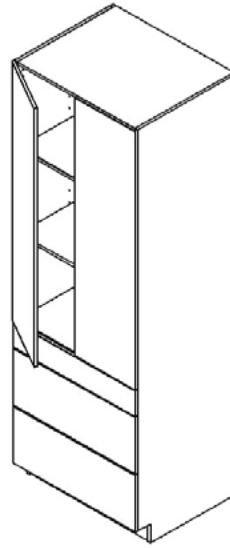

- Two split door sections

Width: 24, 27, 30, 33, 36
Height: 84, 90, 93, 96
Depth: 21, 24, 26

TKM DM SM SC

LHC Linen Hamper Cabinet

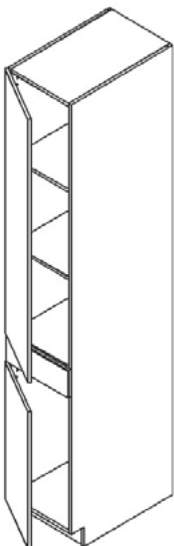

- Specify hinge L/R

Width: 9, 12, 15, 18, 21, 24
Height: 84, 90, 93, 96
Depth: 12, 15, 18, 21, 24 (std), 26

TKM SM SC

LHC Linen Hamper Cabinet

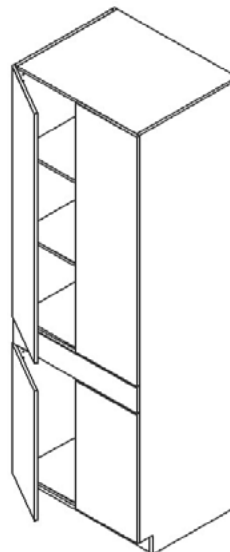

- Two split door sections

Width: 24, 27, 30, 33, 36
Height: 84, 90, 93, 96
Depth: 12, 15, 18, 21, 24 (std), 26

TKM SM SC

UC Utility Cabinet

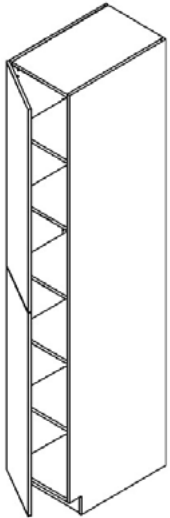

- Specify hinge L/R

Width: 9, 12, 15, 18, 21, 24
 Height: 84, 90, 93, 96
 Depth: 12, 15, 18, 21, 24, 26

TKM SM SC

UC Utility Cabinet

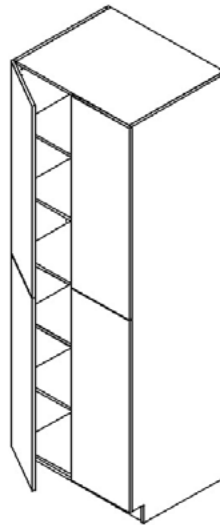

- Two split door sections

Width: 24, 27, 30, 33, 36
 Height: 84, 90, 93, 96
 Depth: 12, 15, 18, 21, 24, 26

TKM SM SC

OC Oven Cabinet w/ 2 Doors Below

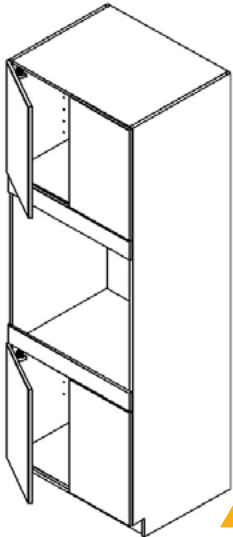

- Two split door sections
- Upper doors min 12" tall
- Lower doors align with base cabinets

Width: 27, 30
 Height: 84, 90, 93, 96
 Depth: 24, 26

TKM SC

⚠ Requires appliance trim kit to hide unfinished interior

OOC Double Oven w/ 1 Drawer Below

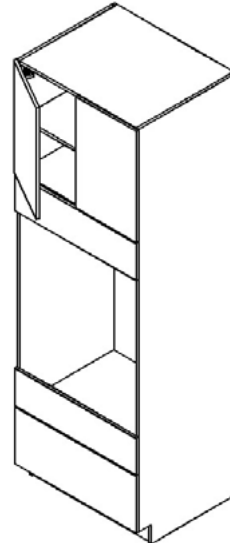

- Two split door sections
- Upper doors min 12" tall
- Lower drawers align with D3B base cabinet

Width: 27, 30
 Height: 84, 90, 93, 96
 Depth: 24, 26

TKM DM SC

O2C Double Oven w/ 1 Drawer Below

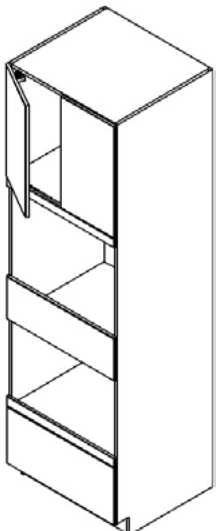

- Two split door sections
- Often designed to custom fit appliances
- Lower drawer

Width: 27, 30
 Height: 84, 90, 93, 96
 Depth: 24, 26

TKM DM SC

OC2D Oven Cabinet w/ 2 Drawer

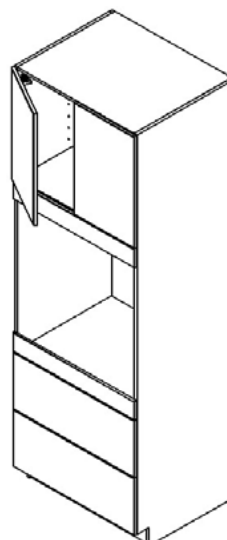

- Two split door sections
- Upper doors min 12" tall
- Lower drawers align with base cabinets

Width: 27, 30
 Height: 84, 90, 93, 96
 Depth: 24, 26

TKM DM SC

OC3D Single Oven w/ 3 Drawers Below

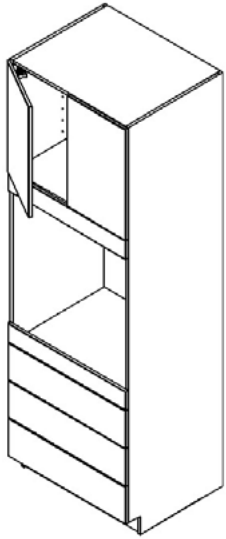

- Upper doors min 12" tall
- Lower drawers align with D4B base cabinet

Width: 27, 30
Height: 84, 90, 93, 96
Depth: 24, 26

TKM DM SC

OC3DF Single Oven w/ 3 Drawers Below (Tall Bottom Drawer)

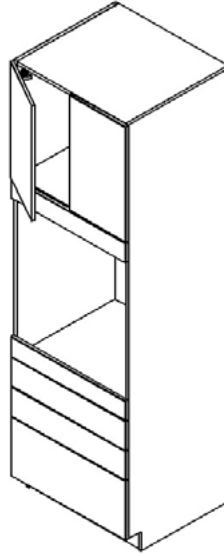

- Upper doors min 12" tall
- Lower drawers align with D4BF base cabinet

Width: 27, 30
Height: 84, 90, 93, 96
Depth: 24, 26

TKM DM SC

TBS Tall Book Shelf

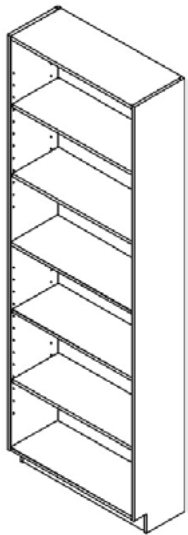

- Color matching interior

Width: 9, 12, 15, 18, 21, 24, 27,
30, 33, 36
Height: 84, 90, 93, 96
Depth: 12, 15, 18, 21, 24, 26

TKM SM

CABINET DEPTH:

- 12
- 15
- 18
- 21
- 24(STD)
- 26

DOORS:

- 09-24W Single Door
- Specify Hinge L/R
- 24-39W Double Door
- 3-inch increments

CODE TEMPLATE:

CODE: HCKL
WIDTH: 15
HEIGHT: 84
HINGE: L
DEPTH: 21

HCKL1584-L-21D*
**Non std depth added to code*

EXAMPLES:

HCKL1284-L, HCKL2490-L/R, HCKL2784,
HCKL1593-L-21D, HCKL2796-21D

ACCESSIBLE TALL CABINETS

HCKL HC Kitchen Linen Single Door

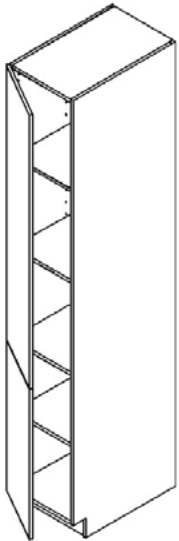

- Specify hinge L/R
- Bottom doors align with HC base cabinet heights

Width: 9, 12, 15, 18, 21, 24
Height: 84, 90, 93, 96
Depth: 12, 15, 18, 21, 24, 26

TKM SM SC

HCKL HC Kitchen Linen Double Door

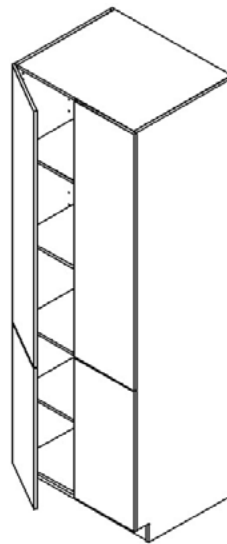

- Two split door sections
- Bottom doors align with HC base cabinet heights

Width: 24, 27, 30, 36
Height: 84, 90, 93, 96
Depth: 12, 15, 18, 21, 24, 26

TKM SM SC

HCKLD3B HC Kitchen Linen 3 Drawer Base

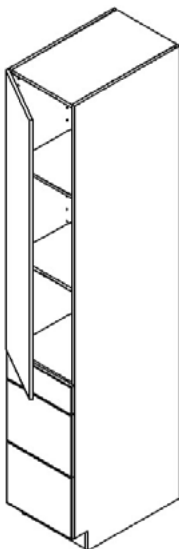

- Specify hinge L/R
- Lower drawers align with the HCD3B base cabinet

Width: 9, 12, 15, 18, 21, 24
Height: 84, 90, 93, 96
Depth: 21, 24, 26

TKM DM SM SC

HCKLD3B HC Kitchen Linen 3 Drawer Base

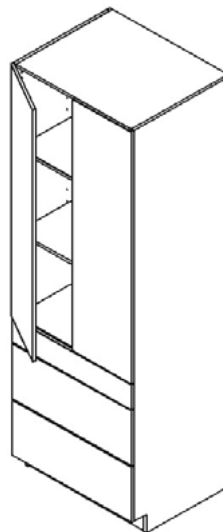

- Two split door sections
- Lower drawers align with the HCD3B base cabinet

Width: 24, 27, 30, 33, 36
Height: 84, 90, 93, 96
Depth: 21, 24, 26

TKM DM SM SC

HCOC HC Single Oven w/ 2 Doors Below

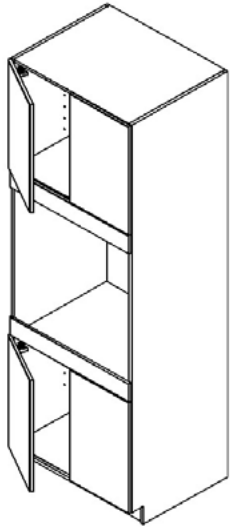

- Two split door sections
- Upper doors min 12" tall
- Lower doors are 18" H and align with HC base cabinets

Width: 27, 30
Height: 84, 90, 93, 96
Depth: 24, 26

TKM SC

HCO2C HC Double Oven w/ 1 Drawer Below

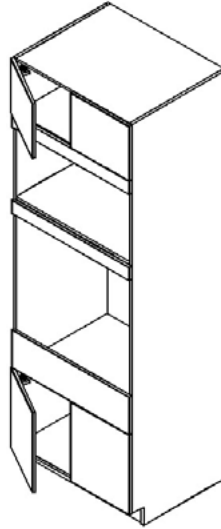

- Two split door sections
- Often designed to custom fit appliances
- Lower doors are 18" H and align with HC base cabinets

Width: 27, 30
Height: 84, 90, 93, 96
Depth: 24, 26

TKM SC

VANITY TALL CABINETS

VL Vanity Kitchen Linen Single Door

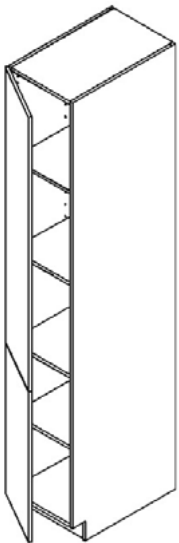

- Specify hinge L/R
- Bottom doors align with VB base cabinet heights

Width: 9, 12, 15, 18, 21, 24
Height: 84, 90, 93, 96
Depth: 12, 15, 18, 21, 24, 26

TKM SM SC

VL Vanity Kitchen Linen Double Door

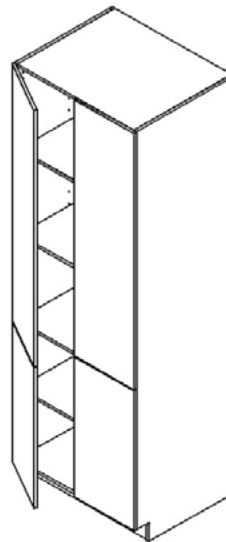

- Two split door sections
- Bottom doors align with VB base cabinet heights

Width: 24, 27, 30, 36
Height: 84, 90, 93, 96
Depth: 12, 15, 18, 21, 24, 26

TKM SM SC

BAFFLE Baffle

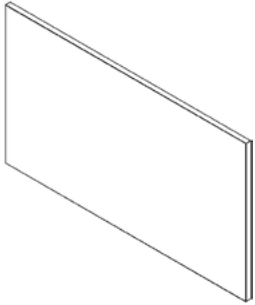

Width: 9, 12, 15, 18, 21, 24, 27, 30, 31 1/2, 33, 36, 39

DOOR Applied Doors



- Specify dimension

BRP Return Panel w/ Filler

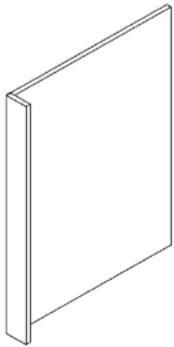

Width: 3, 6
Height: 34-1/2
Depth: 21, 24

BRPOL Return Panel Overlay

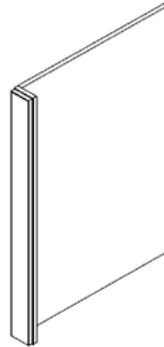

Width: 3, 6
Height: 34-1/2
Depth: 21, 24

EPB End Panel Base

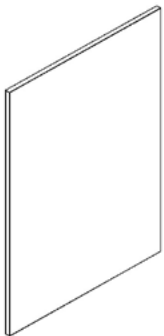

Height: 28-1/2, 31-1/2, 32-1/2, 34-1/2,
Depth: 12, 15, 18, 21, 24, 26
Thick: 5/8

EPT End Panel Tall



Height: 54, 84, 90, 93, 96
Depth: 12, 15, 18, 21, 24, 26
Thick: 5/8

SHELVING16 Shelving 5/8"



Length: 96
Depth: 12, 24

⚠ Shelf deflection occurs on widths wider than 36" without proper support

TK Toe Kick

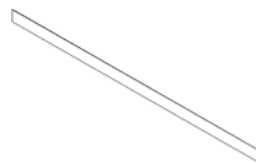

- Color matching toe kick

Length: 96
Height: 4
Thick: 1/8

EPW End Panel Wall



Height: 12, 15, 18, 21, 24, 27, 30, 36, 39, 42
Depth: 12, 15, 18, 21, 24, 26
Thick: 5/8

IBP Island Back Panel

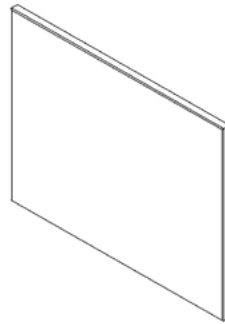

- Width = Across Grain
- Length = Along Grain

Width: 12, 15, 18, 21, 24, 27, 30, 31 1/2, 33, 36, 39, 42, 45, 48
Length: 12, 15, 18, 24, 27, 28 1/2, 30, 31 1/2, 32 1/2, 34 1/2, 36, 39, 42, 54, 84, 90, 93, 96
Thick: 5/8

CLEAT Cleat

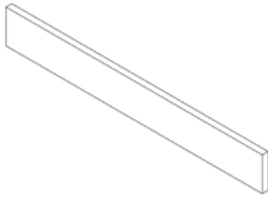

- Cleat

Length: 96
Height: 4
Thick: 5/8

SH16 Shelf 5/8"
SH19 Shelf 3/4"

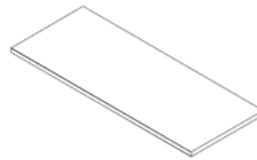

- 1/2" shallower than cabinet depth
- Requires a cleat around perimeter for installation

Length: 9, 12, 15, 18, 21, 24, 27, 30, 33, 36
Depth: 9, 12, 15, 18, 21, 24
Thick: 3/4 or 5/8

STV Valance

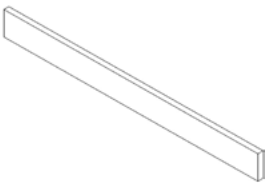

- Horizontal grain only

Length: 12, 15, 18, 21, 24, 27, 30, 31 1/2, 33, 36, 39, 42, 45, 48
Height: 3

STVOL Overlay Valance

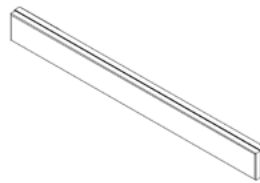

- Standard valance with overlay

Length: 12, 15, 18, 21, 24, 27, 30, 31 1/2, 33, 36, 39, 42, 45, 48
Height: 3

LTR Light Rail



Length: 96
Height: 2

RF Range front

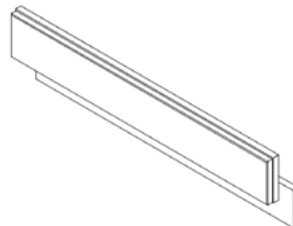

- Range front

Length: 24, 27, 30, 33, 36
Height: 4

FW Wall Fillers



Width: 3, 6, 9
Height: 12, 15, 18, 21, 24, 27,
30, 36, 39, 42

FWOL Wall Overlay Fillers



- Standard filler with door panel on face

Width: 3, 6, 9
Height: 12, 15, 18, 21, 24, 27,
30, 36, 39, 42

⚠ *Overlay fillers should not be used for 3/4" starter fillers*

FB Base Filler



Width: 3, 6, 9
Height: 28 1/2, 31 1/2, 32 1/2,
34 1/2

FBOL Base Overlay Filler



- Standard filler with door panel on face

Width: 3, 6, 9
Height: 28 1/2, 31 1/2, 32 1/2,
34 1/2

⚠ *Overlay fillers should not be used for 3/4" starter fillers*

FT Tall Filler



Width: 3, 6, 9
Height: 84, 90, 93, 96

FTOL Tall Overlay Filler



- Standard filler with door panel on face

Width: 3, 6, 9
Height: 84, 90, 93, 96

⚠ *Overlay fillers should not be used for 3/4" starter fillers*

FWR Wall Return Fillers

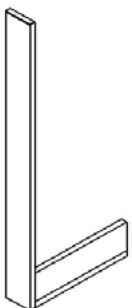

Width: 3, 6, 9
Height: 12, 15, 18, 21, 24, 27,
30, 36, 39, 42
Depth: 9, 12, 15, 18, 21, 24

FWROL Return Overlay Fillers



- Standard filler with door panel on face

Width: 3, 6, 9
Height: 12, 15, 18, 21, 24, 27,
30, 36, 39, 42

Depth: 12, 15

⚠ *Overlay fillers should not be used for 3/4" starter fillers*

METAL LEG Metal Furniture Foot

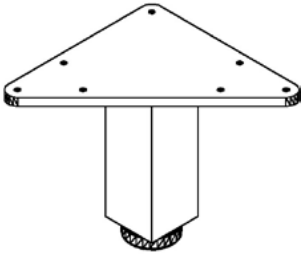

- Metal furniture foot with leveler and mounting bracket
- Brushed finish

Size: 30mm x 30mm
Height: 4

⚠ One leg is needed to support each end of a cabinet run and one leg needed to support the joint between two cabinets.

AWS Angled Wall Support

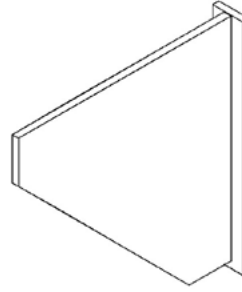

Width: 4
Height: 21
Depth: 21

SKT Skirt

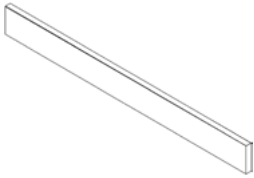

- Skirt

Height: 3

HCBRP HC Return Panel w/ Filler

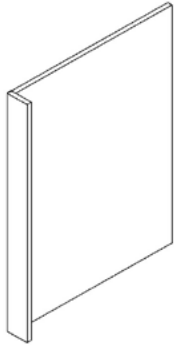

- M= Melamine
- P= Paper

Width: 3, 6
 Height: 321/2
 Depth: 21, 24

HCBRPOL HC Return Panel Overlay

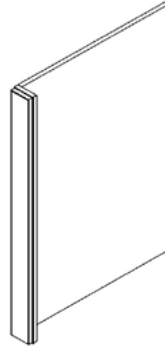

- M= Melamine
- P= Paper

Width: 3, 6
 Height: 321/2
 Depth: 21, 24

VRP Vanity Return Panel w/ Filler

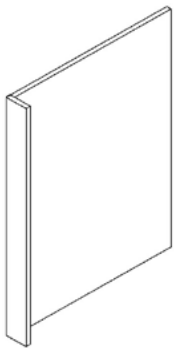

- M= Melamine
- P= Paper

Width: 3, 6
 Height: 311/2
 Depth: 21, 24

VRPOL Vanity Return Panel Overlay

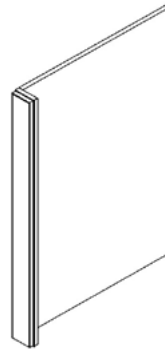

- M= Melamine
- P= Paper

Width: 3, 6
 Height: 311/2
 Depth: 21, 24

DRP Desk Return Panel w/ Filler

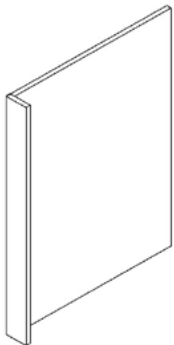

- M= Melamine
- P= Paper

Width: 3, 6
 Height: 281/2
 Depth: 21, 24

DRPOL Desk Return Panel Overlay

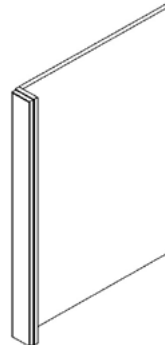

- M= Melamine
- P= Paper

Width: 3, 6
 Height: 281/2
 Depth: 21, 24

WRP Wall Return Panel w/ Filler



- M= Melamine
- P= Paper

Width: 3, 6
 Height: 12, 15, 18, 21, 24, 27,
 30, 36, 39, 42
 Depth: 12, 15

WRPOL Wall Return Panel Overlay

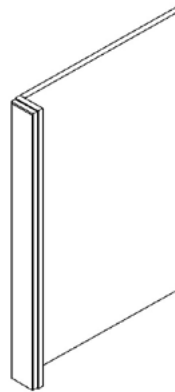

- M= Melamine
- P= Paper

Width: 3, 6
 Height: 12, 15, 18, 21, 24, 27,
 30, 36, 39, 42
 Depth: 12, 15



©2016 LEEDO EUROPEAN CATALOG 1/16

NOTICE: The European cabinet specifications appearing herein supersede and cancel all previous sheets, supplements and addenda, and represent current manufacturing standards and procedures. Leedo Cabinetry reserves the right to make specification changes for continued product improvement. Leedo warrants all structural aspects of our products for a period of one year, excluding the results of normal wear and tear and damages that arise from misuse of product.

NOTE: Due to various printing limitations or monitor displays, color pictures cannot be guaranteed to exactly match the actual cabinet material.